

## LM2940-N/LM2940C 1A Low Dropout Regulator

 Check for Samples: [LM2940-N](#), [LM2940C](#)

### FEATURES

- Dropout Voltage Typically 0.5V @  $I_O = 1A$
- Output Current in Excess of 1A
- Output Voltage Trimmed Before Assembly
- Reverse Battery Protection
- Internal Short Circuit Current Limit
- Mirror Image Insertion Protection
- P<sup>+</sup> Product Enhancement Tested

### DESCRIPTION

The LM2940-N/LM2940C positive voltage regulator features the ability to source 1A of output current with a dropout voltage of typically 0.5V and a maximum of 1V over the entire temperature range. Furthermore, a quiescent current reduction circuit has been included which reduces the ground current when the differential between the input voltage and the output voltage exceeds approximately 3V. The quiescent current with 1A of output current and an input-output differential of 5V is therefore only 30 mA. Higher quiescent currents only exist when the regulator is in the dropout mode ( $V_{IN} - V_{OUT} \leq 3V$ ).

Designed also for vehicular applications, the LM2940-N/LM2940C and all regulated circuitry are protected from reverse battery installations or 2-battery jumps. During line transients, such as load dump when the input voltage can momentarily exceed the specified maximum operating voltage, the regulator will automatically shut down to protect both the internal circuits and the load. The LM2940/LM2940C cannot be harmed by temporary mirror-image insertion. Familiar regulator features such as short circuit and thermal overload protection are also provided.

### Typical Application

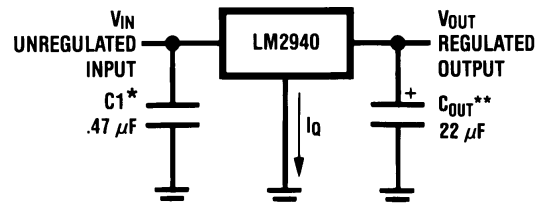

\*Required if regulator is located far from power supply filter.

\*\* $C_{OUT}$  must be at least 22  $\mu F$  to maintain stability. May be increased without bound to maintain regulation during transients. Locate as close as possible to the regulator. This capacitor must be rated over the same operating temperature range as the regulator and the ESR is critical; see curve.



Please be aware that an important notice concerning availability, standard warranty, and use in critical applications of Texas Instruments semiconductor products and disclaimers thereto appears at the end of this data sheet.

All trademarks are the property of their respective owners.

Connection Diagrams

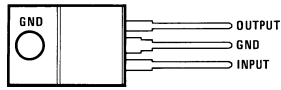

Figure 1. TO-220 (NDE) Plastic Package Front View  
See Package Number NDE0003B

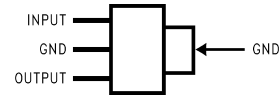

Figure 2. SOT-223 (DCY) 3-Lead Front View  
See Package Number DCY0004A

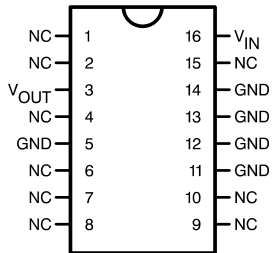

Figure 3. 16-Lead CDIP (NFE) Top View  
See Package Number NFE0016A

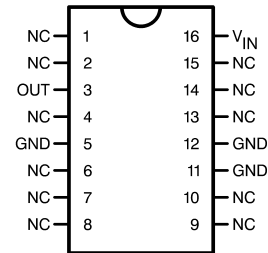

Figure 4. 16-Lead CLGA (NAC) Top View  
See Package Number NAC0016A

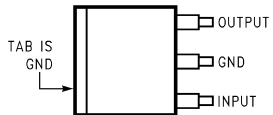

Figure 5. DDPAK/ TO-263 (KTT) Top View



Figure 6. Side View  
See Package Number KTT0003B

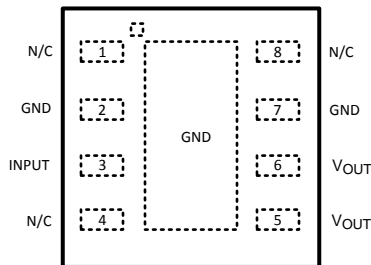

Figure 7. WSON (NGN) 8-Lead Top View  
See Package Number NGN0008A

Pin 2 and pin 7 are fused to center DAP  
Pin 5 and 6 need to be tied together on PCB board



These devices have limited built-in ESD protection. The leads should be shorted together or the device placed in conductive foam during storage or handling to prevent electrostatic damage to the MOS gates.

**Absolute Maximum Ratings** <sup>(1)(2)</sup>

LM2940-N KTT, NFE, NAC, NDE, DCY $\leq$ 100 ms		60V
LM2940C KTT, NDE $\leq$ 1 ms		45V
Internal Power Dissipation <sup>(3)</sup>		Internally Limited
Maximum Junction Temperature		150°C
Storage Temperature Range		$-65^{\circ}\text{C} \leq T_J \leq +150^{\circ}\text{C}$
Soldering Temperature <sup>(4)</sup>	TO-220 (NDE), Wave	260°C, 10s
	DDPAK/ TO-263 (KTT)	235°C, 30s
	SOT-223 (DCY)	260°C, 30s
	WSO-8 (NGN)	235°C, 30s
ESD Susceptibility <sup>(5)</sup>		2 kV

- (1) Absolute Maximum Ratings are limits beyond which damage to the device may occur. Operating Conditions are conditions under which the device functions but the specifications might not be ensured. For ensured specifications and test conditions see the Electrical Characteristics.
- (2) If Military/Aerospace specified devices are required, please contact the Texas Instruments Sales Office/ Distributors for availability and specifications.
- (3) The maximum allowable power dissipation is a function of the maximum junction temperature,  $T_J$ , the junction-to-ambient thermal resistance,  $\theta_{JA}$ , and the ambient temperature,  $T_A$ . Exceeding the maximum allowable power dissipation will cause excessive die temperature, and the regulator will go into thermal shutdown. The value of  $\theta_{JA}$  (for devices in still air with no heatsink) is 60°C/W for the TO-220 package, 80°C/W for the DDPAK/TO-263 package, and 174°C/W for the SOT-223 package. The effective value of  $\theta_{JA}$  can be reduced by using a heatsink (see [Application Hints](#) for specific information on heatsinking). The value of  $\theta_{JA}$  for the WSON package is specifically dependent on PCB trace area, trace material, and the number of layers and thermal vias. For improved thermal resistance and power dissipation for the WSON package, refer to Application Note AN-1187 ([SNOA401](#)). It is recommended that 6 vias be placed under the center pad to improve thermal performance.
- (4) Refer to JEDEC J-STD-020C for surface mount device (SMD) package reflow profiles and conditions. Unless otherwise stated, the temperature and time are for Sn-Pb (STD) only.
- (5) ESD rating is based on the human body model, 100 pF discharged through 1.5 k $\Omega$ .

**Operating Conditions** <sup>(1)</sup>

Input Voltage		26V
Temperature Range	LM2940-N NDE, LM2940-N KTT	$-40^{\circ}\text{C} \leq T_J \leq 125^{\circ}\text{C}$
	LM2940C NDE, LM2940C KTT	$0^{\circ}\text{C} \leq T_J \leq 125^{\circ}\text{C}$
	LM2940-N DCY	$-40^{\circ}\text{C} \leq T_A \leq 85^{\circ}\text{C}$
	LM2940-N NFE, LM2940-N NAC	$-55^{\circ}\text{C} \leq T_J \leq 125^{\circ}\text{C}$
	LM2940-N NGN	$-40^{\circ}\text{C} \leq T_J \leq 125^{\circ}\text{C}$

- (1) Absolute Maximum Ratings are limits beyond which damage to the device may occur. Operating Conditions are conditions under which the device functions but the specifications might not be ensured. For ensured specifications and test conditions see the Electrical Characteristics.

## Electrical Characteristics

$V_{IN} = V_O + 5V$ ,  $I_O = 1A$ ,  $C_O = 22 \mu F$ , unless otherwise specified. **Boldface limits apply over the entire operating temperature range of the indicated device.** All other specifications apply for  $T_A = T_J = 25^\circ C$ .

Output Voltage ( $V_O$ )		5V			8V			Units
Parameter	Conditions	Typ	LM2940-N Limit <sup>(1)</sup>	LM2940-N/883 Limit <sup>(2)</sup>	Typ	LM2940-N Limit <sup>(1)</sup>	LM2940-N/883 Limit <sup>(2)</sup>	
Output Voltage	$5 \text{ mA} \leq I_O \leq 1 \text{ A}$	<b><math>6.25V \leq V_{IN} \leq 26V</math></b>			<b><math>9.4V \leq V_{IN} \leq 26V</math></b>			$V_{MIN}$ $V_{MAX}$
		5.00	4.85/4.75 5.15/5.25	4.85/4.75 5.15/5.25	8.00	7.76/7.60 8.24/8.40	7.76/7.60 8.24/8.40	
Line Regulation	$V_O + 2V \leq V_{IN} \leq 26V$ , $I_O = 5 \text{ mA}$	20	50	40/50	20	80	50/80	$mV_{MAX}$
Load Regulation	$50 \text{ mA} \leq I_O \leq 1 \text{ A}$ LM2940-N, LM2940-N/883 LM2940C	35	50/80	50/100	55	80/130	80/130	$mV_{MAX}$
		35	50		55	80		
Output Impedance	100 mADC and 20 mArms, $f_O = 120 \text{ Hz}$	35		1000/1000	55		1000/1000	$m\Omega$
Quiescent Current	$V_O + 2V \leq V_{IN} \leq 26V$ , $I_O = 5 \text{ mA}$ LM2940-N, LM2940-N/883 LM2940C	10	15/20	15/20	10	15/20	15/20	$mA_{MAX}$
		10	15					
	$V_{IN} = V_O + 5V$ , $I_O = 1 \text{ A}$	30	45/60	50/60	30	45/60	50/60	$mA_{MAX}$
Output Noise Voltage	10 Hz – 100 kHz, $I_O = 5 \text{ mA}$	150		700/700	240		1000/1000	$\mu V_{rms}$
Ripple Rejection	$f_O = 120 \text{ Hz}$ , $1 V_{rms}$ , $I_O = 100 \text{ mA}$ LM2940-N LM2940C	72	60/54		66	54/48		$dB_{MIN}$
		72	60		66	54		
	$f_O = 1 \text{ kHz}$ , $1 V_{rms}$ , $I_O = 5 \text{ mA}$			60/50			54/48	$dB_{MIN}$
Long Term Stability		20			32			$mV/$ 1000 Hr
Dropout Voltage	$I_O = 1 \text{ A}$	0.5	0.8/1.0	0.7/1.0	0.5	0.8/1.0	0.7/1.0	$V_{MAX}$
	$I_O = 100 \text{ mA}$	110	150/200	150/200	110	150/200	150/200	$mV_{MAX}$
Short Circuit Current	See <sup>(3)</sup>	1.9	1.6	1.5/1.3	1.9	1.6	1.6/1.3	$A_{MIN}$
Maximum Line Transient	$R_O = 100\Omega$ LM2940-N, $T \leq 100 \text{ ms}$	75	60/60		75	60/60		$V_{MIN}$
	LM2940-N/883, $T \leq 20 \text{ ms}$			40/40			40/40	
	LM2940C, $T \leq 1 \text{ ms}$	55	45		55	45		
Reverse Polarity DC Input Voltage	$R_O = 100\Omega$ LM2940-N, LM2940-N/883 LM2940C	-30 -30	-15/-15 -15	-15/-15	-30 -30	-15/-15 -15	-15/-15	$V_{MIN}$

- (1) All limits are specified at  $T_A = T_J = 25^\circ C$  only (standard typeface) or over the entire operating temperature range of the indicated device (boldface type). All limits at  $T_A = T_J = 25^\circ C$  are 100% production tested. All limits at temperature extremes are specified via correlation using standard Statistical Quality Control methods.
- (2) All limits are specified at  $T_A = T_J = 25^\circ C$  only (standard typeface) or over the entire operating temperature range of the indicated device (boldface type). All limits are 100% production tested and are used to calculate Outgoing Quality Levels.
- (3) Output current will decrease with increasing temperature but will not drop below 1A at the maximum specified temperature.

### Electrical Characteristics (continued)

$V_{IN} = V_O + 5V$ ,  $I_O = 1A$ ,  $C_O = 22 \mu F$ , unless otherwise specified. **Boldface limits apply over the entire operating temperature range of the indicated device.** All other specifications apply for  $T_A = T_J = 25^\circ C$ .

Output Voltage ( $V_O$ )		5V			8V			Units
Parameter	Conditions	Typ	LM2940-N Limit <sup>(1)</sup>	LM2940-N/883 Limit <sup>(2)</sup>	Typ	LM2940-N Limit <sup>(1)</sup>	LM2940-N/883 Limit <sup>(2)</sup>	
Reverse Polarity Transient Input Voltage	$R_O = 100\Omega$							$V_{MIN}$
	LM2940-N, $T \leq 100$ ms	-75	-50/-50		-75	-50/-50		
	LM2940-N/883, $T \leq 20$ ms			-45/-45			-45/-45	
	LM2940C, $T \leq 1$ ms	-55	-45/-45					

### Electrical Characteristics

$V_{IN} = V_O + 5V$ ,  $I_O = 1A$ ,  $C_O = 22 \mu F$ , unless otherwise specified. **Boldface limits apply over the entire operating temperature range of the indicated device.** All other specifications apply for  $T_A = T_J = 25^\circ C$ .

Output Voltage ( $V_O$ )		9V		10V		Units
Parameter	Conditions	Typ	LM2940-N	Typ	LM2940-N	
			Limit		Limit	
			(1)		(1)	
Output Voltage	$5 \text{ mA} \leq I_O \leq 1A$	$10.5V \leq V_{IN} \leq 26V$		$11.5V \leq V_{IN} \leq 26V$		$V_{MIN}$ $V_{MAX}$
		9.00	8.73/ <b>8.55</b> 9.27/ <b>9.45</b>	10.00	9.70/ <b>9.50</b> 10.30/ <b>10.50</b>	
Line Regulation	$V_O + 2V \leq V_{IN} \leq 26V$ , $I_O = 5 \text{ mA}$	20	90	20	100	$mV_{MAX}$
Load Regulation	$50 \text{ mA} \leq I_O \leq 1A$ LM2940-N LM2940C	60	90/ <b>150</b>	65	100/ <b>165</b>	$mV_{MAX}$
		60	90			
Output Impedance	100 mADC and 20 mArms, $f_O = 120 \text{ Hz}$	60		65		$m\Omega$
Quiescent Current	$V_O + 2V \leq V_{IN} < 26V$ , $I_O = 5 \text{ mA}$ LM2940-N LM2940C	10	15/ <b>20</b>	10	15/ <b>20</b>	$mA_{MAX}$
		10	15			
		$V_{IN} = V_O + 5V$ , $I_O = 1A$	30	45/ <b>60</b>	30	
Output Noise Voltage	10 Hz – 100 kHz, $I_O = 5 \text{ mA}$	270		300		$\mu V_{rms}$
Ripple Rejection	$f_O = 120 \text{ Hz}$ , $1 V_{rms}$ , $I_O = 100 \text{ mA}$ LM2940-N LM2940C	64	52/ <b>46</b>	63	51/ <b>45</b>	$dB_{MIN}$
		64	52			
Long Term Stability		34		36		$mV/$ 1000 Hr
Dropout Voltage	$I_O = 1A$	0.5	0.8/ <b>1.0</b>	0.5	0.8/ <b>1.0</b>	$V_{MAX}$
	$I_O = 100 \text{ mA}$	110	150/ <b>200</b>	110	150/ <b>200</b>	$mV_{MAX}$
Short Circuit Current	See <sup>(2)</sup>	1.9	1.6	1.9	1.6	$A_{MIN}$

(1) All limits are specified at  $T_A = T_J = 25^\circ C$  only (standard typeface) or over the entire operating temperature range of the indicated device (boldface type). All limits at  $T_A = T_J = 25^\circ C$  are 100% production tested. All limits at temperature extremes are specified via correlation using standard Statistical Quality Control methods.

(2) Output current will decrease with increasing temperature but will not drop below 1A at the maximum specified temperature.

**Electrical Characteristics (continued)**

$V_{IN} = V_O + 5V$ ,  $I_O = 1A$ ,  $C_O = 22 \mu F$ , unless otherwise specified. **Boldface limits apply over the entire operating temperature range of the indicated device.** All other specifications apply for  $T_A = T_J = 25^\circ C$ .

Output Voltage ( $V_O$ )		9V		10V		Units
Parameter	Conditions	Typ	LM2940-N	Typ	LM2940-N	
			Limit		Limit	
			(1)		(1)	
Maximum Line Transient	$R_O = 100\Omega$					$V_{MIN}$
	$T \leq 100 \text{ ms}$					
Reverse Polarity DC Input Voltage	LM2940-N	75	<b>60/60</b>	75	<b>60/60</b>	$V_{MIN}$
	LM2940C	55	45			
Reverse Polarity Transient Input Voltage	$R_O = 100\Omega$					$V_{MIN}$
	$T \leq 100 \text{ ms}$					
Reverse Polarity Transient Input Voltage	LM2940-N	-30	<b>-15/-15</b>	-30	<b>-15/-15</b>	$V_{MIN}$
	LM2940C	-30	-15			
Reverse Polarity Transient Input Voltage	$R_O = 100\Omega$					$V_{MIN}$
	$T \leq 100 \text{ ms}$					
Reverse Polarity Transient Input Voltage	LM2940-N	-75	<b>-50/-50</b>	-75	<b>-50/-50</b>	$V_{MIN}$
	LM2940C	-55	<b>-45/-45</b>			

**Electrical Characteristics**

$V_{IN} = V_O + 5V$ ,  $I_O = 1A$ ,  $C_O = 22 \mu F$ , unless otherwise specified. **Boldface limits apply over the entire operating temperature range of the indicated device.** All other specifications apply for  $T_A = T_J = 25^\circ C$ .

Output Voltage ( $V_O$ )		12V			15V			Units
Parameter	Conditions	Typ	LM2940-N Limit (1)	LM2940-N/833 Limit (2)	Typ	LM2940-N Limit (1)	LM2940-N/833 Limit (2)	
Output Voltage	$5 \text{ mA} \leq I_O \leq 1A$	<b><math>13.6V \leq V_{IN} \leq 26V</math></b>			<b><math>16.75V \leq V_{IN} \leq 26V</math></b>			$V_{MIN}$
		12.0 0	<b>11.64/11.40</b>	<b>11.64/11.40</b>	15.0 0	<b>14.55/14.25</b>	<b>14.55/14.25</b>	
			<b>12.36/12.60</b>	<b>12.36/12.60</b>		<b>15.45/15.75</b>	<b>15.45/15.75</b>	$V_{MAX}$
Line Regulation	$V_O + 2V \leq V_{IN} \leq 26V$ , $I_O = 5 \text{ mA}$	20	120	<b>75/120</b>	20	150	<b>95/150</b>	$mV_{MAX}$
Load Regulation	$50 \text{ mA} \leq I_O \leq 1A$ LM2940-N, LM2940-N/883 LM2940C	55	<b>120/200</b>	<b>120/190</b>			<b>150/240</b>	$mV_{MAX}$
		55	120		70	150		
Output Impedance	100 mADC and 20 mArms, $f_O = 120 \text{ Hz}$	80		<b>1000/1000</b>	100		<b>1000/1000</b>	$m\Omega$
Quiescent Current	$V_O + 2V \leq V_{IN} \leq 26V$ , $I_O = 5 \text{ mA}$ LM2940-N, LM2940-N/883 LM2940C	10	<b>15/20</b>	<b>15/20</b>			<b>15/20</b>	$mA_{MAX}$
		10	15		10	15		
		30	<b>45/60</b>	<b>50/60</b>	30	<b>45/60</b>	<b>50/60</b>	
Output Noise Voltage	10 Hz – 100 kHz, $I_O = 5 \text{ mA}$	360		<b>1000/1000</b>	450		<b>1000/1000</b>	$\mu V_{rms}$

(1) All limits are specified at  $T_A = T_J = 25^\circ C$  only (standard typeface) or over the entire operating temperature range of the indicated device (boldface type). All limits at  $T_A = T_J = 25^\circ C$  are 100% production tested. All limits at temperature extremes are specified via correlation using standard Statistical Quality Control methods.

(2) All limits are specified at  $T_A = T_J = 25^\circ C$  only (standard typeface) or over the entire operating temperature range of the indicated device (boldface type). All limits are 100% production tested and are used to calculate Outgoing Quality Levels.

## Electrical Characteristics (continued)

$V_{IN} = V_O + 5V$ ,  $I_O = 1A$ ,  $C_O = 22 \mu F$ , unless otherwise specified. **Boldface limits apply over the entire operating temperature range of the indicated device.** All other specifications apply for  $T_A = T_J = 25^\circ C$ .

Output Voltage ( $V_O$ )		12V			15V			Units
Parameter	Conditions	Typ	LM2940-N Limit <sup>(1)</sup>	LM2940-N/833 Limit <sup>(2)</sup>	Typ	LM2940-N Limit <sup>(1)</sup>	LM2940-N/833 Limit <sup>(2)</sup>	
Ripple Rejection	$f_O = 120 \text{ Hz}$ , $1 V_{rms}$ , $I_O = 100 \text{ mA}$	66	<b>54/48</b>		64	52		$\text{dB}_{MIN}$
	$f_O = 1 \text{ kHz}$ , $1 V_{rms}$ , $I_O = 5 \text{ mA}$			<b>52/46</b>			<b>48/42</b>	$\text{dB}_{MIN}$
Long Term Stability		48			60			$\text{mV}/1000 \text{ Hr}$
Dropout Voltage	$I_O = 1A$	0.5	<b>0.8/1.0</b>	<b>0.7/1.0</b>	0.5	<b>0.8/1.0</b>	<b>0.7/1.0</b>	$V_{MAX}$
	$I_O = 100 \text{ mA}$	110	<b>150/200</b>	<b>150/200</b>	110	<b>150/200</b>	<b>150/200</b>	$\text{mV}_{MAX}$
Short Circuit Current	See <sup>(3)</sup>	1.9	1.6	<b>1.6/1.3</b>	1.9	1.6	<b>1.6/1.3</b>	$A_{MIN}$
Maximum Line Transient	$R_O = 100\Omega$							
	LM2940-N, $T \leq 100 \text{ ms}$	75	<b>60/60</b>					$V_{MIN}$
	LM2940-N/833, $T \leq 20 \text{ ms}$ LM2940C, $T \leq 1 \text{ ms}$	55	45	<b>40/40</b>	55	45	<b>40/40</b>	$V_{MIN}$
Reverse Polarity DC Input Voltage	$R_O = 100\Omega$							
	LM2940-N, LM2940-N/833 LM2940C	-30 -30	<b>-15/-15</b> -15	<b>-15/-15</b>	-30	-15	<b>-15/-15</b>	$V_{MIN}$
Reverse Polarity Transient Input Voltage	$R_O = 100\Omega$							
	LM2940-N, $T \leq 100 \text{ ms}$	-75	<b>-50/-50</b>					$V_{MIN}$
	LM2940-N/833, $T \leq 20 \text{ ms}$ LM2940C, $T \leq 1 \text{ ms}$	-55	<b>-45/-45</b>	<b>-45/-45</b>	-55	<b>-45/-45</b>	<b>-45/-45</b>	$V_{MIN}$

(3) Output current will decrease with increasing temperature but will not drop below 1A at the maximum specified temperature.

## Thermal Performance

Thermal Resistance Junction-to-Case, $\theta_{(JC)}$	3-Lead TO-220	4	$^\circ C/W$
	3-Lead DDPAK/TO-263	4	
Thermal Resistance Junction-to-Ambient, $\theta_{(JA)}$	3-Lead TO-220 <sup>(1)</sup>	60	$^\circ C/W$
	3-Lead DDPAK/TO-263 <sup>(1)</sup>	80	
	SOT-223 <sup>(1)</sup>	174	
	8-Lead WSON <sup>(1)</sup>	35	

(1) The maximum allowable power dissipation is a function of the maximum junction temperature,  $T_J$ , the junction-to-ambient thermal resistance,  $\theta_{JA}$ , and the ambient temperature,  $T_A$ . Exceeding the maximum allowable power dissipation will cause excessive die temperature, and the regulator will go into thermal shutdown. The value of  $\theta_{JA}$  (for devices in still air with no heatsink) is  $60^\circ C/W$  for the TO-220 package,  $80^\circ C/W$  for the DDPAK/TO-263 package, and  $174^\circ C/W$  for the SOT-223 package. The effective value of  $\theta_{JA}$  can be reduced by using a heatsink (see [Application Hints](#) for specific information on heatsinking). The value of  $\theta_{JA}$  for the WSON package is specifically dependent on PCB trace area, trace material, and the number of layers and thermal vias. For improved thermal resistance and power dissipation for the WSON package, refer to Application Note AN-1187 ([SNOA401](#)). It is recommended that 6 vias be placed under the center pad to improve thermal performance.

Typical Performance Characteristics

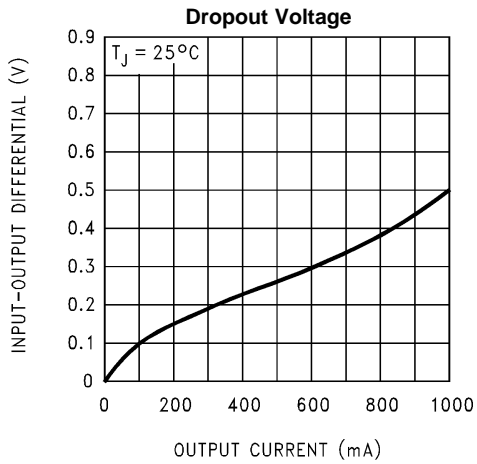

Figure 8.

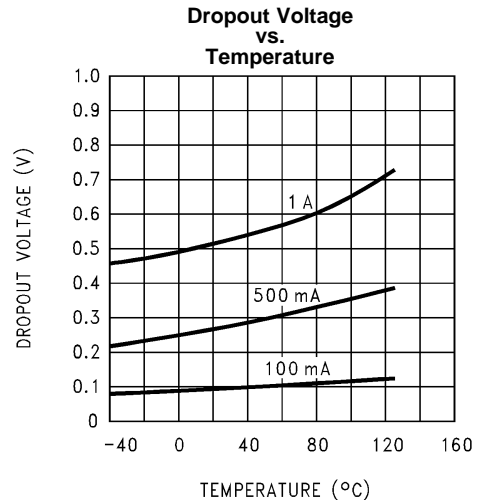

Figure 9.

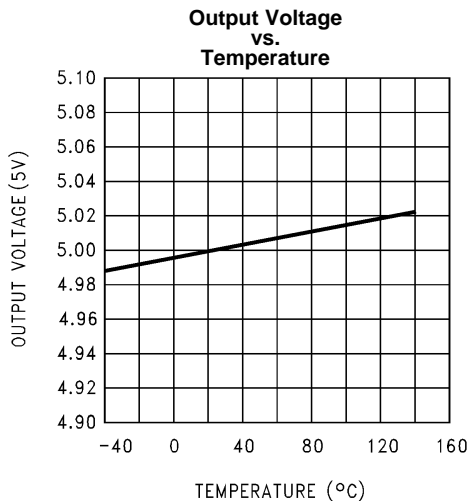

Figure 10.

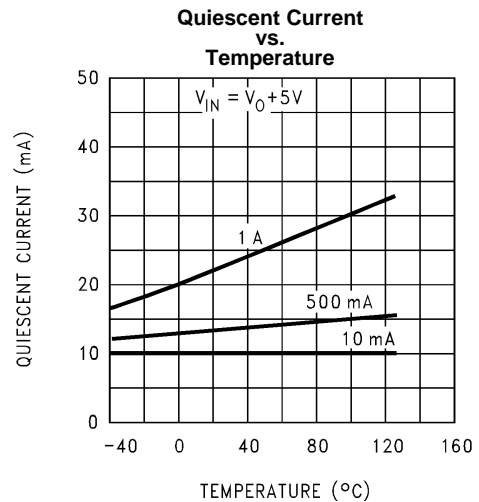

Figure 11.

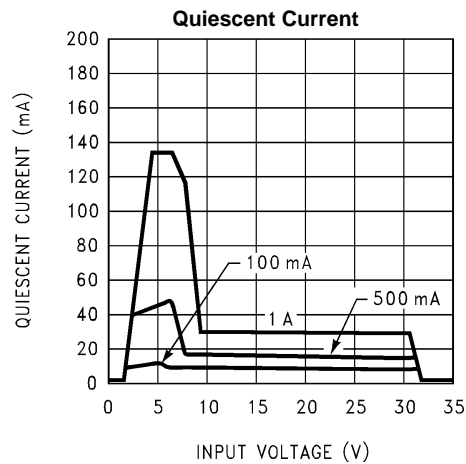

Figure 12.

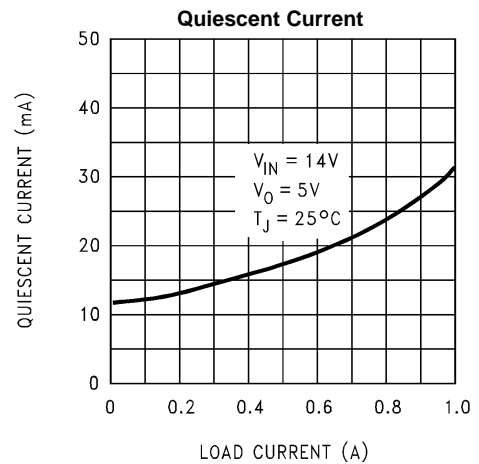

Figure 13.



Typical Performance Characteristics (continued)

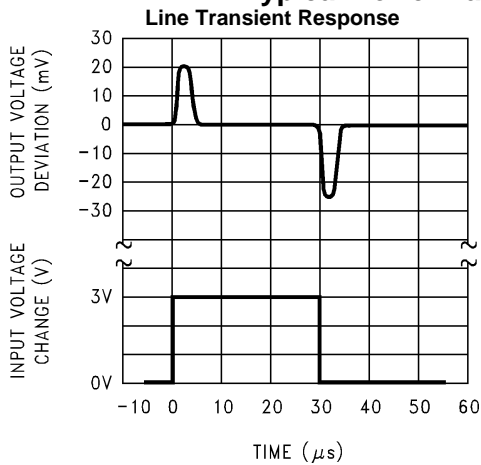

Figure 14.

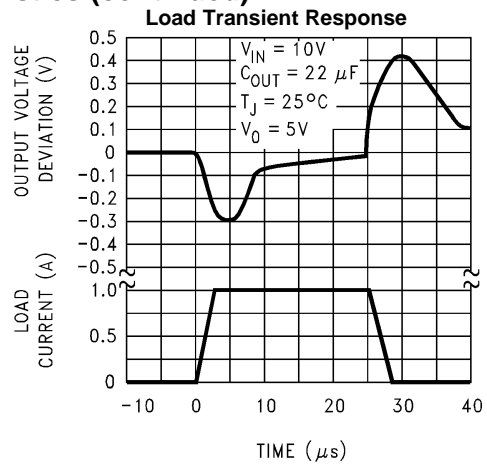

Figure 15.

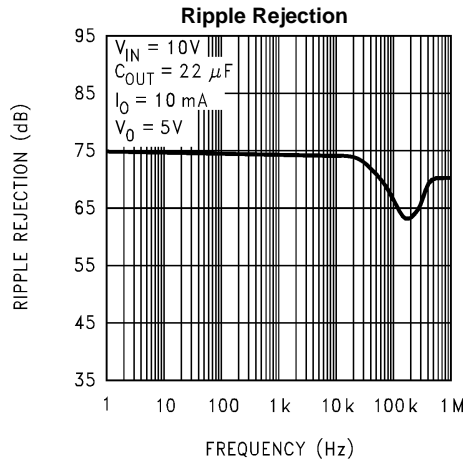

Figure 16.

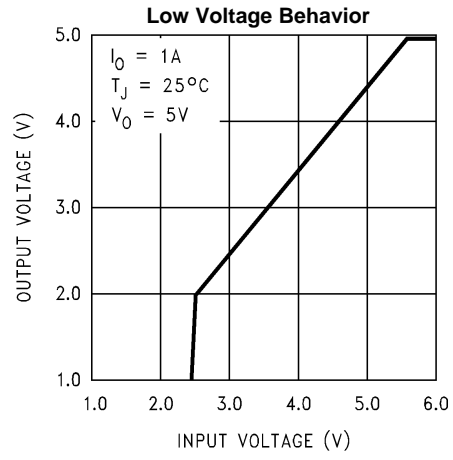

Figure 17.

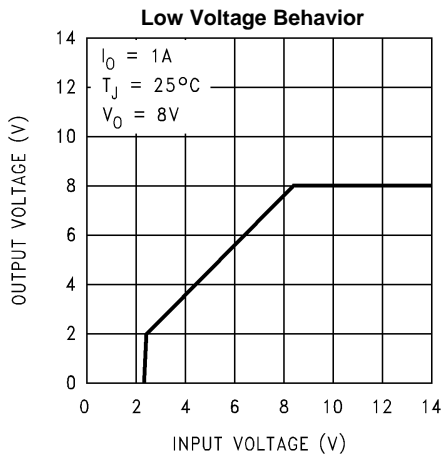

Figure 18.

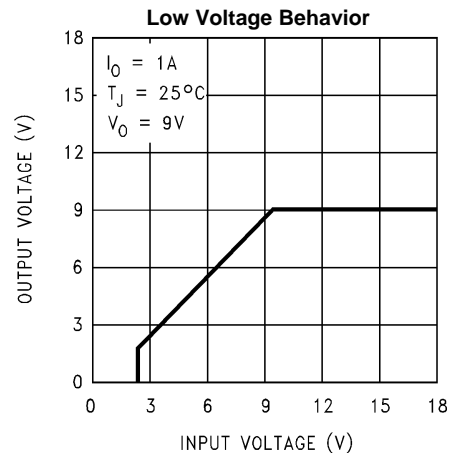

Figure 19.

**Typical Performance Characteristics (continued)**

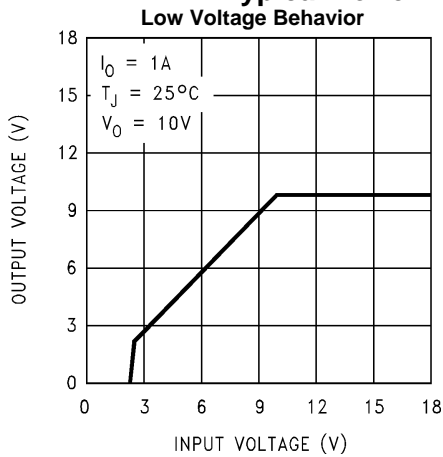

Figure 20.

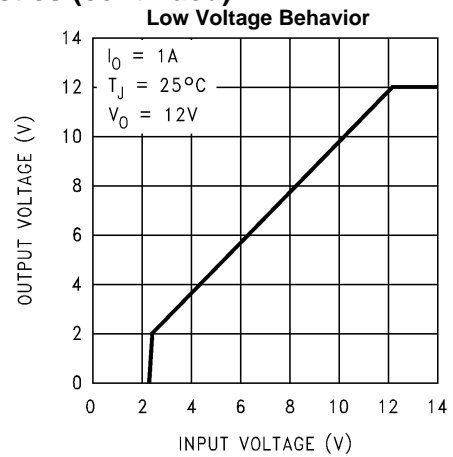

Figure 21.

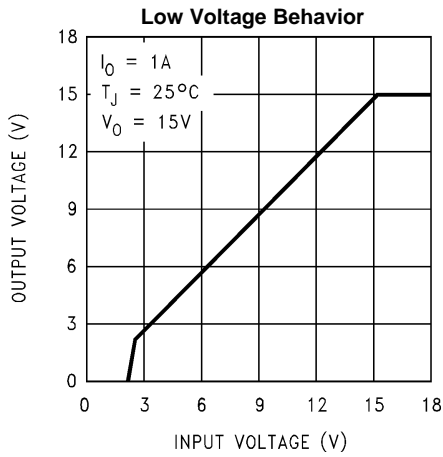

Figure 22.

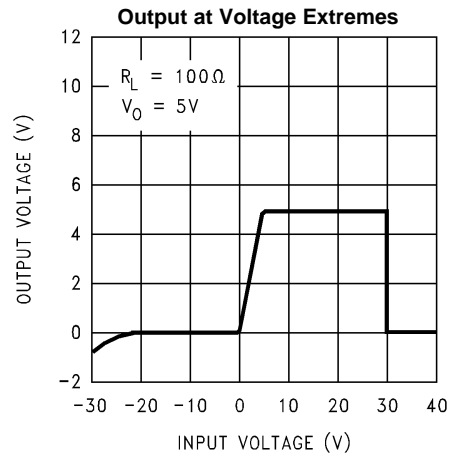

Figure 23.

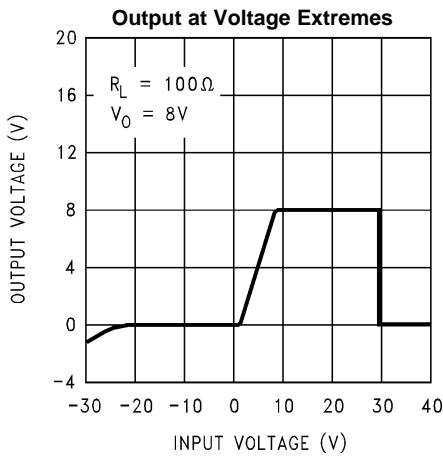

Figure 24.

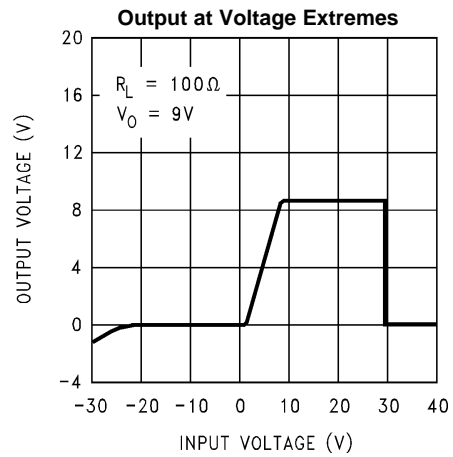
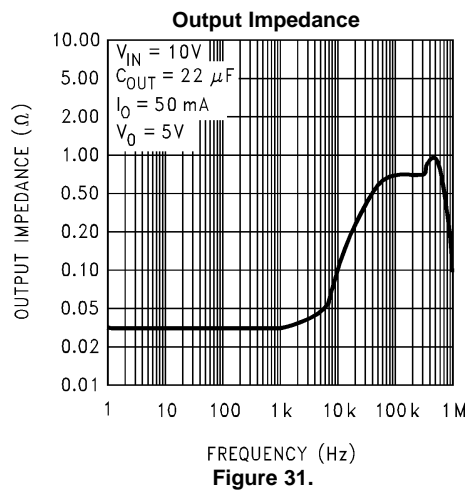
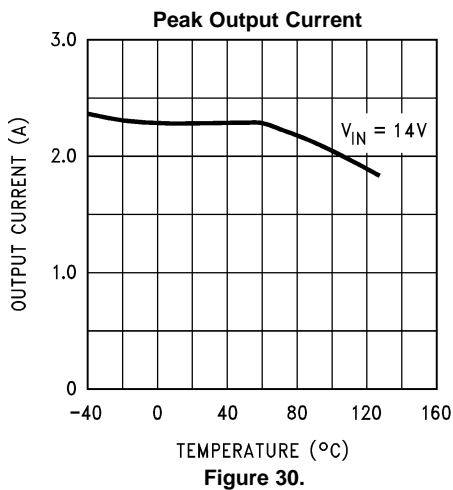
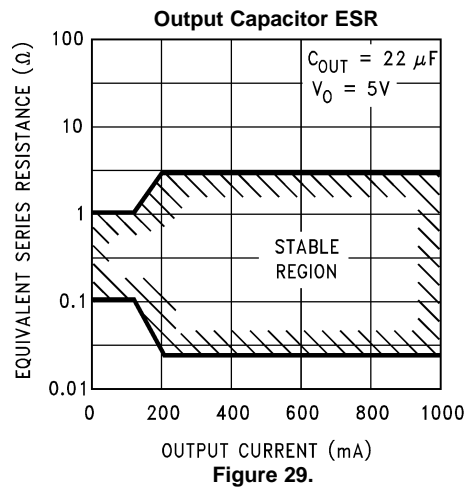
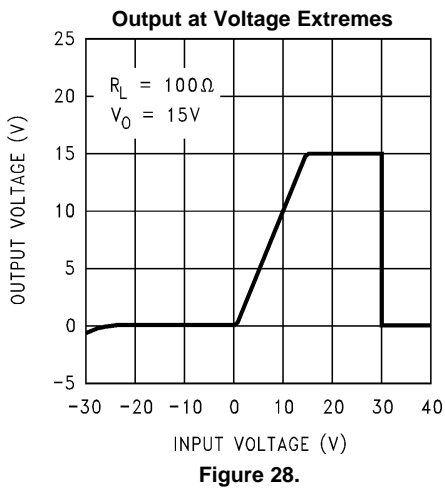
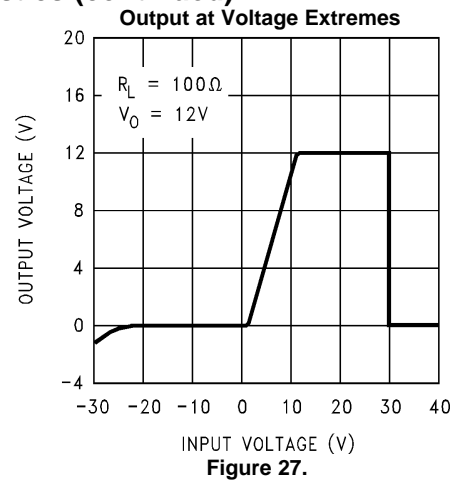
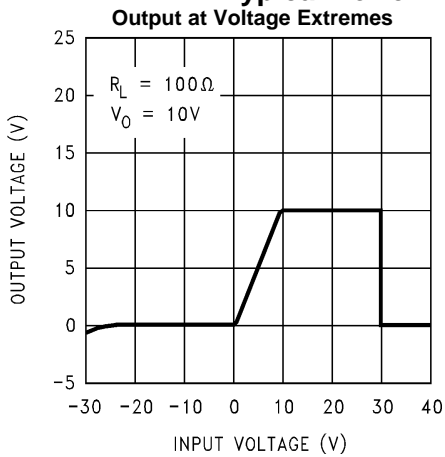

Figure 25.

Typical Performance Characteristics (continued)



**Typical Performance Characteristics (continued)**

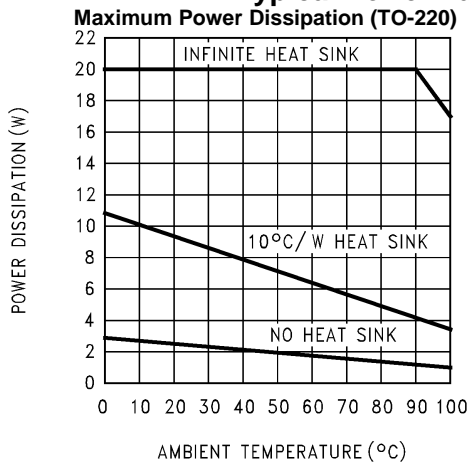

Figure 32.

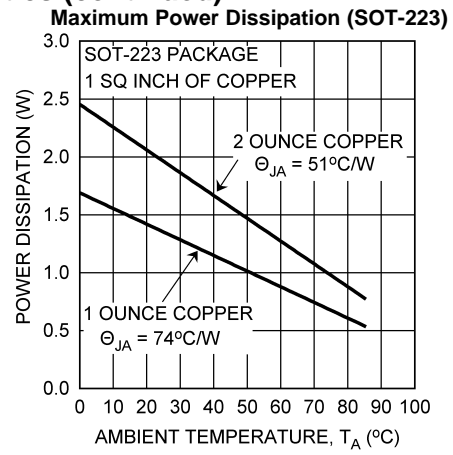

Figure 33.

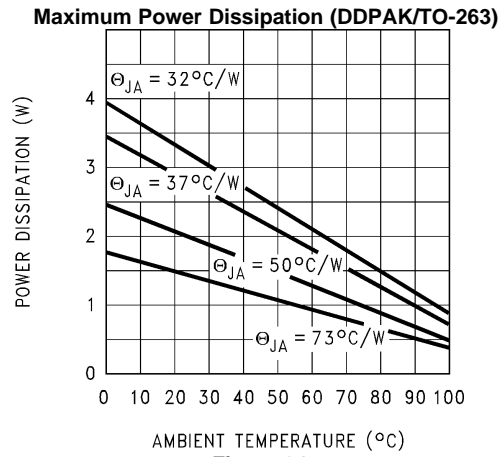
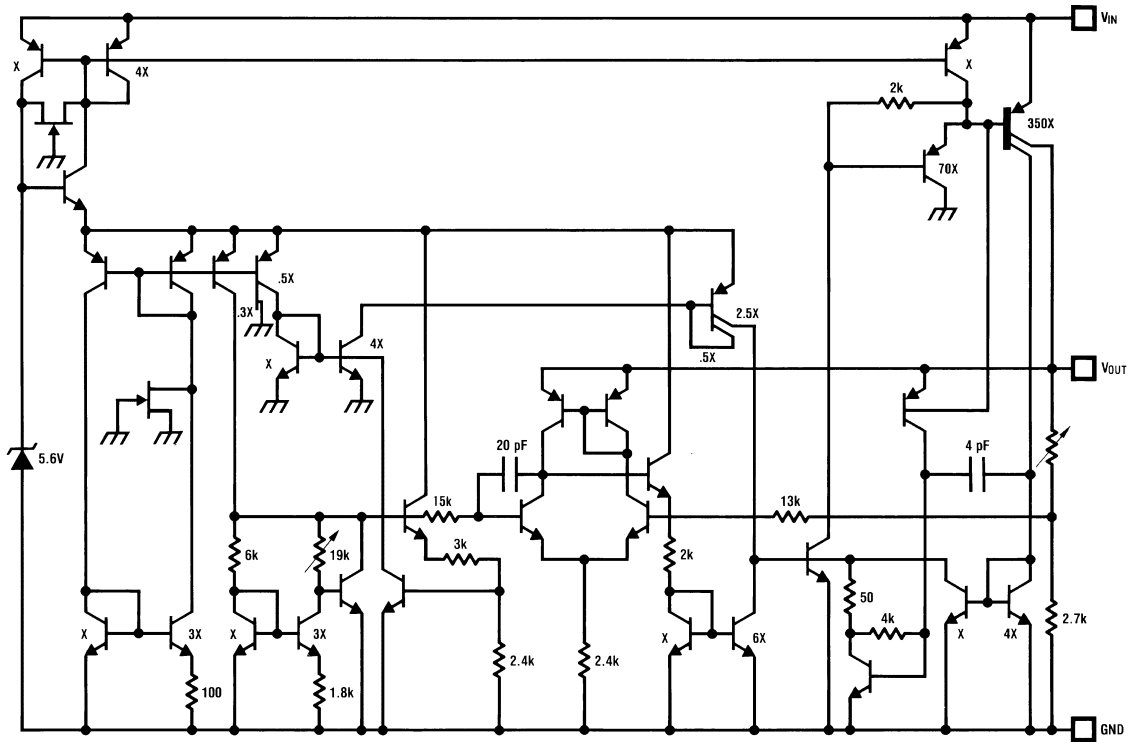

Figure 34.

Equivalent Schematic Diagram



## APPLICATION INFORMATION

### EXTERNAL CAPACITORS

The output capacitor is critical to maintaining regulator stability, and must meet the required conditions for both ESR (Equivalent Series Resistance) and minimum amount of capacitance.

#### MINIMUM CAPACITANCE:

The minimum output capacitance required to maintain stability is 22  $\mu\text{F}$  (this value may be increased without limit). Larger values of output capacitance will give improved transient response.

#### ESR LIMITS:

The ESR of the output capacitor will cause loop instability if it is too high or too low. The acceptable range of ESR plotted versus load current is shown in the graph below. ***It is essential that the output capacitor meet these requirements, or oscillations can result.***

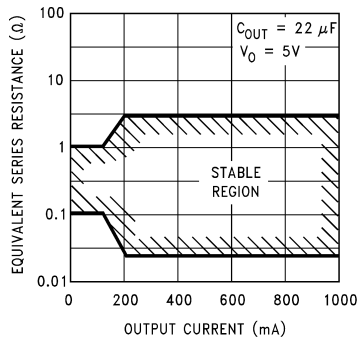

**Figure 35. Output Capacitor ESR Limits**

It is important to note that for most capacitors, ESR is specified only at room temperature. However, the designer must ensure that the ESR will stay inside the limits shown over the entire operating temperature range for the design.

For aluminum electrolytic capacitors, ESR will increase by about 30X as the temperature is reduced from 25°C to -40°C. This type of capacitor is not well-suited for low temperature operation.

Solid tantalum capacitors have a more stable ESR over temperature, but are more expensive than aluminum electrolytics. A cost-effective approach sometimes used is to parallel an aluminum electrolytic with a solid Tantalum, with the total capacitance split about 75/25% with the Aluminum being the larger value.

If two capacitors are paralleled, the effective ESR is the parallel of the two individual values. The “flatter” ESR of the Tantalum will keep the effective ESR from rising as quickly at low temperatures.

### HEATSINKING

A heatsink may be required depending on the maximum power dissipation and maximum ambient temperature of the application. Under all possible operating conditions, the junction temperature must be within the range specified under Absolute Maximum Ratings.

To determine if a heatsink is required, the power dissipated by the regulator,  $P_D$ , must be calculated.

The figure below shows the voltages and currents which are present in the circuit, as well as the formula for calculating the power dissipated in the regulator:

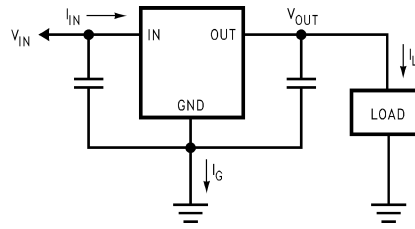

$$I_{IN} = I_L + I_G$$

$$P_D = (V_{IN} - V_{OUT}) I_L + (V_{IN}) I_G$$

Figure 36. Power Dissipation Diagram

The next parameter which must be calculated is the maximum allowable temperature rise,  $T_{R(MAX)}$ . This is calculated by using the formula:

$$T_{R(MAX)} = T_{J(MAX)} - T_{A(MAX)}$$

where

- $T_{J(MAX)}$  is the maximum allowable junction temperature, which is 125°C for commercial grade parts.
- $T_{A(MAX)}$  is the maximum ambient temperature which will be encountered in the application. (1)

Using the calculated values for  $T_{R(MAX)}$  and  $P_D$ , the maximum allowable value for the junction-to-ambient thermal resistance,  $\theta_{(JA)}$ , can now be found:

$$\theta_{(JA)} = T_{R(MAX)} / P_D \quad (2)$$

#### NOTE

If the maximum allowable value for  $\theta_{(JA)}$  is found to be  $\geq 53^\circ\text{C/W}$  for the TO-220 package,  $\geq 80^\circ\text{C/W}$  for the DDPAK/TO-263 package, or  $\geq 174^\circ\text{C/W}$  for the SOT-223 package, no heatsink is needed since the package alone will dissipate enough heat to satisfy these requirements.

If the calculated value for  $\theta_{(JA)}$  falls below these limits, a heatsink is required.

### HEATSINKING TO-220 PACKAGE PARTS

The TO-220 can be attached to a typical heatsink, or secured to a copper plane on a PC board. If a copper plane is to be used, the values of  $\theta_{(JA)}$  will be the same as shown in the next section for the DDPAK/TO-263.

If a manufactured heatsink is to be selected, the value of heatsink-to-ambient thermal resistance,  $\theta_{(H-A)}$ , must first be calculated:

$$\theta_{(H-A)} = \theta_{(JA)} - \theta_{(C-H)} - \theta_{(J-C)}$$

where

- $\theta_{(J-C)}$  is defined as the thermal resistance from the junction to the surface of the case. A value of 3°C/W can be assumed for  $\theta_{(J-C)}$  for this calculation.
- $\theta_{(C-H)}$  is defined as the thermal resistance between the case and the surface of the heatsink. The value of  $\theta_{(C-H)}$  will vary from about 1.5°C/W to about 2.5°C/W (depending on method of attachment, insulator, etc.). If the exact value is unknown, 2°C/W should be assumed for  $\theta_{(C-H)}$ . (3)

When a value for  $\theta_{(H-A)}$  is found using the equation shown, a heatsink must be selected that has a value that is less than or equal to this number.

$\theta_{(H-A)}$  is specified numerically by the heatsink manufacturer in the catalog, or shown in a curve that plots temperature rise vs power dissipation for the heatsink.

### HEATSINKING DDPAK/TO-263 PACKAGE PARTS

The DDPAK/TO-263 (KTT) package uses a copper plane on the PCB and the PCB itself as a heatsink. To optimize the heat sinking ability of the plane and PCB, solder the tab of the package to the plane.

Figure 37 shows for the DDPAK/TO-263 the measured values of  $\theta_{(JA)}$  for different copper area sizes using a typical PCB with 1 ounce copper and no solder mask over the copper area used for heatsinking.

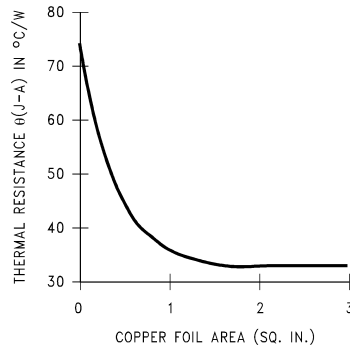

**Figure 37.  $\theta_{(JA)}$  vs. Copper (1 ounce) Area for the DDPAK/TO-263 Package**

As shown in the figure, increasing the copper area beyond 1 square inch produces very little improvement. It should also be observed that the minimum value of  $\theta_{(JA)}$  for the DDPAK/TO-263 package mounted to a PCB is 32°C/W.

As a design aid, [Figure 38](#) shows the maximum allowable power dissipation compared to ambient temperature for the DDPAK/TO-263 device. This assumes a  $\theta_{(JA)}$  of 35°C/W for 1 square inch of 1 ounce copper and a maximum junction temperature ( $T_J$ ) of 125°C.

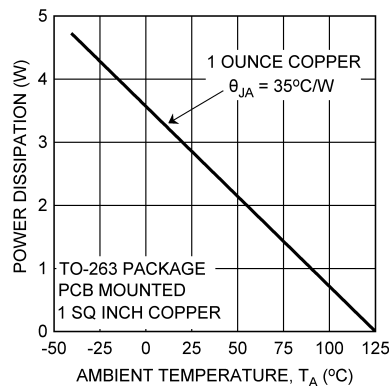

**Figure 38. Maximum Power Dissipation vs.  $T_A$  for the DDPAK/TO-263 Package**

### HEATSINKING SOT-223 PACKAGE PARTS

The SOT-223 (DCY) packages use a copper plane on the PCB and the PCB itself as a heatsink. To optimize the heat sinking ability of the plane and PCB, solder the tab of the package to the plane.

[Figure 39](#) and [Figure 40](#) show the information for the SOT-223 package. [Figure 40](#) assumes a  $\theta_{(JA)}$  of 74°C/W for 1 square inch of 1 ounce copper and 51°C/W for 1 square inch of 2 ounce copper, with a maximum ambient temperature ( $T_A$ ) of 85°C and a maximum junction temperature ( $T_J$ ) of 125°C.

For techniques for improving the thermal resistance and power dissipation for the SOT-223 package, please refer to Application Note AN-1028 ([SNVA036](#)).



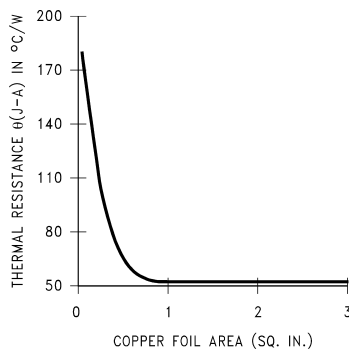

Figure 39.  $\theta_{(JA)}$  vs. Copper (2 ounce) Area for the SOT-223 Package

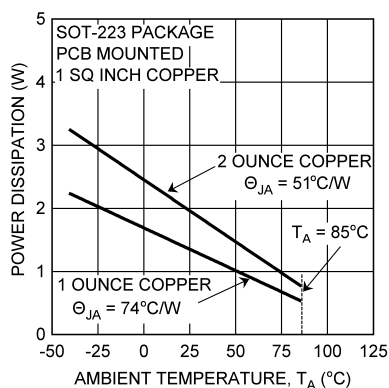

Figure 40. Maximum Power Dissipation vs.  $T_A$  for the SOT-223 Package

### HEATSINKING WSON PACKAGE PARTS

The value of  $\theta_{JA}$  for the WSON package is specifically dependent on PCB trace area, trace material, and the number of layers and thermal vias. It is recommended that a minimum of 6 thermal vias be placed under the center pad to improve thermal performance.

For techniques for improving the thermal resistance and power dissipation for the WSON package, please refer to Application Note AN-1187 ([SNOA401](#)).

## REVISION HISTORY

Changes from Revision H (April 2013) to Revision I	Page
• Changed layout of National Data Sheet to TI format .....	<a href="#">17</a>

**PACKAGING INFORMATION**

Orderable Device	Status (1)	Package Type	Package Drawing	Pins	Package Qty	Eco Plan (2)	Lead/Ball Finish	MSL Peak Temp (3)	Op Temp (°C)	Top-Side Markings (4)	Samples
LM2940CS-12	ACTIVE	DDPAK/ TO-263	KTT	3	45	TBD	Call TI	Call TI	0 to 125	LM2940CS -12 P+	<a href="#">Samples</a>
LM2940CS-12/NOPB	ACTIVE	DDPAK/ TO-263	KTT	3	45	Pb-Free (RoHS Exempt)	CU SN	Level-3-245C-168 HR	0 to 125	LM2940CS -12 P+	<a href="#">Samples</a>
LM2940CS-15	ACTIVE	DDPAK/ TO-263	KTT	3	45	TBD	Call TI	Call TI	0 to 125	LM2940CS -15 P+	<a href="#">Samples</a>
LM2940CS-15/NOPB	ACTIVE	DDPAK/ TO-263	KTT	3	45	Pb-Free (RoHS Exempt)	CU SN	Level-3-245C-168 HR	0 to 125	LM2940CS -15 P+	<a href="#">Samples</a>
LM2940CS-5.0	ACTIVE	DDPAK/ TO-263	KTT	3	45	TBD	Call TI	Call TI	0 to 125	LM2940CS -5.0 P+	<a href="#">Samples</a>
LM2940CS-5.0/NOPB	ACTIVE	DDPAK/ TO-263	KTT	3	45	Pb-Free (RoHS Exempt)	CU SN	Level-3-245C-168 HR	0 to 125	LM2940CS -5.0 P+	<a href="#">Samples</a>
LM2940CS-9.0	ACTIVE	DDPAK/ TO-263	KTT	3	45	TBD	Call TI	Call TI	0 to 125	LM2940CS -9.0 P+	<a href="#">Samples</a>
LM2940CS-9.0/NOPB	ACTIVE	DDPAK/ TO-263	KTT	3	45	Pb-Free (RoHS Exempt)	CU SN	Level-3-245C-168 HR	0 to 125	LM2940CS -9.0 P+	<a href="#">Samples</a>
LM2940CSX-12	ACTIVE	DDPAK/ TO-263	KTT	3	500	TBD	Call TI	Call TI	0 to 125	LM2940CS -12 P+	<a href="#">Samples</a>
LM2940CSX-12/NOPB	ACTIVE	DDPAK/ TO-263	KTT	3	500	Pb-Free (RoHS Exempt)	CU SN	Level-3-245C-168 HR	0 to 125	LM2940CS -12 P+	<a href="#">Samples</a>
LM2940CSX-15	ACTIVE	DDPAK/ TO-263	KTT	3	500	TBD	Call TI	Call TI	0 to 125	LM2940CS -15 P+	<a href="#">Samples</a>
LM2940CSX-15/NOPB	ACTIVE	DDPAK/ TO-263	KTT	3	500	Pb-Free (RoHS Exempt)	CU SN	Level-3-245C-168 HR	0 to 125	LM2940CS -15 P+	<a href="#">Samples</a>
LM2940CSX-5.0	ACTIVE	DDPAK/ TO-263	KTT	3	500	TBD	Call TI	Call TI	0 to 125	LM2940CS -5.0 P+	<a href="#">Samples</a>
LM2940CSX-5.0/NOPB	ACTIVE	DDPAK/ TO-263	KTT	3	500	Pb-Free (RoHS Exempt)	CU SN	Level-3-245C-168 HR	0 to 125	LM2940CS -5.0 P+	<a href="#">Samples</a>
LM2940CSX-9.0	ACTIVE	DDPAK/ TO-263	KTT	3	500	TBD	Call TI	Call TI	0 to 125	LM2940CS -9.0 P+	<a href="#">Samples</a>
LM2940CSX-9.0/NOPB	ACTIVE	DDPAK/ TO-263	KTT	3	500	Pb-Free (RoHS Exempt)	CU SN	Level-3-245C-168 HR	0 to 125	LM2940CS -9.0 P+	<a href="#">Samples</a>
LM2940CT-12	ACTIVE	TO-220	NDE	3	45	TBD	Call TI	Call TI	0 to 125	LM2940CT -12 P+	<a href="#">Samples</a>

Orderable Device	Status (1)	Package Type	Package Drawing	Pins	Package Qty	Eco Plan (2)	Lead/Ball Finish	MSL Peak Temp (3)	Op Temp (°C)	Top-Side Markings (4)	Samples
LM2940CT-12/NOPB	ACTIVE	TO-220	NDE	3	45	Green (RoHS & no Sb/Br)	CU SN	Level-1-NA-UNLIM	0 to 125	LM2940CT -12 P+	<a href="#">Samples</a>
LM2940CT-15	ACTIVE	TO-220	NDE	3	45	TBD	Call TI	Call TI	0 to 125	LM2940CT -15 P+	<a href="#">Samples</a>
LM2940CT-15/NOPB	ACTIVE	TO-220	NDE	3	45	Green (RoHS & no Sb/Br)	CU SN	Level-1-NA-UNLIM	0 to 125	LM2940CT -15 P+	<a href="#">Samples</a>
LM2940CT-5.0	ACTIVE	TO-220	NDE	3	45	TBD	Call TI	Call TI	0 to 125	LM2940CT -5.0 P+	<a href="#">Samples</a>
LM2940CT-5.0/LF01	ACTIVE	TO-220	NDG	3	45	Pb-Free (RoHS Exempt)	CU SN	Level-3-245C-168 HR		LM2940CT -5.0 P+	<a href="#">Samples</a>
LM2940CT-5.0/NOPB	ACTIVE	TO-220	NDE	3	45	Green (RoHS & no Sb/Br)	CU SN	Level-1-NA-UNLIM	0 to 125	LM2940CT -5.0 P+	<a href="#">Samples</a>
LM2940CT-9.0	ACTIVE	TO-220	NDE	3	45	TBD	Call TI	Call TI	0 to 125	LM2940CT -9.0 P+	<a href="#">Samples</a>
LM2940CT-9.0/NOPB	ACTIVE	TO-220	NDE	3	45	Green (RoHS & no Sb/Br)	CU SN	Level-1-NA-UNLIM	0 to 125	LM2940CT -9.0 P+	<a href="#">Samples</a>
LM2940IMP-10	ACTIVE	SOT-223	DCY	4	1000	TBD	Call TI	Call TI	-40 to 85	L55B	<a href="#">Samples</a>
LM2940IMP-10/NOPB	ACTIVE	SOT-223	DCY	4	1000	Green (RoHS & no Sb/Br)	CU SN	Level-1-260C-UNLIM	-40 to 85	L55B	<a href="#">Samples</a>
LM2940IMP-12	ACTIVE	SOT-223	DCY	4	1000	TBD	Call TI	Call TI	-40 to 85	L56B	<a href="#">Samples</a>
LM2940IMP-12/NOPB	ACTIVE	SOT-223	DCY	4	1000	Green (RoHS & no Sb/Br)	CU SN	Level-1-260C-UNLIM	-40 to 85	L56B	<a href="#">Samples</a>
LM2940IMP-15	ACTIVE	SOT-223	DCY	4	1000	TBD	Call TI	Call TI	-40 to 85	L70B	<a href="#">Samples</a>
LM2940IMP-15/NOPB	ACTIVE	SOT-223	DCY	4	1000	Green (RoHS & no Sb/Br)	CU SN	Level-1-260C-UNLIM	-40 to 85	L70B	<a href="#">Samples</a>
LM2940IMP-5.0	ACTIVE	SOT-223	DCY	4	1000	TBD	Call TI	Call TI	-40 to 85	L53B	<a href="#">Samples</a>
LM2940IMP-5.0/NOPB	ACTIVE	SOT-223	DCY	4	1000	Green (RoHS & no Sb/Br)	CU SN	Level-1-260C-UNLIM	-40 to 85	L53B	<a href="#">Samples</a>
LM2940IMP-9.0	ACTIVE	SOT-223	DCY	4	1000	TBD	Call TI	Call TI	-40 to 85	L0EB	<a href="#">Samples</a>
LM2940IMP-9.0/NOPB	ACTIVE	SOT-223	DCY	4	1000	Green (RoHS & no Sb/Br)	CU SN	Level-1-260C-UNLIM	-40 to 85	L0EB	<a href="#">Samples</a>
LM2940IMPX-10	ACTIVE	SOT-223	DCY	4	2000	TBD	Call TI	Call TI	-40 to 85	L55B	<a href="#">Samples</a>

Orderable Device	Status (1)	Package Type	Package Drawing	Pins	Package Qty	Eco Plan (2)	Lead/Ball Finish	MSL Peak Temp (3)	Op Temp (°C)	Top-Side Markings (4)	Samples
LM2940IMPX-10/NOPB	ACTIVE	SOT-223	DCY	4	2000	Green (RoHS & no Sb/Br)	CU SN	Level-1-260C-UNLIM	-40 to 85	L55B	<a href="#">Samples</a>
LM2940IMPX-12	ACTIVE	SOT-223	DCY	4	2000	TBD	Call TI	Call TI	-40 to 85	L56B	<a href="#">Samples</a>
LM2940IMPX-12/NOPB	ACTIVE	SOT-223	DCY	4	2000	Green (RoHS & no Sb/Br)	CU SN	Level-1-260C-UNLIM	-40 to 85	L56B	<a href="#">Samples</a>
LM2940IMPX-5.0	ACTIVE	SOT-223	DCY	4	2000	TBD	Call TI	Call TI	-40 to 85	L53B	<a href="#">Samples</a>
LM2940IMPX-5.0/NOPB	ACTIVE	SOT-223	DCY	4	2000	Green (RoHS & no Sb/Br)	CU SN	Level-1-260C-UNLIM	-40 to 85	L53B	<a href="#">Samples</a>
LM2940IMPX-8.0	ACTIVE	SOT-223	DCY	4	2000	TBD	Call TI	Call TI	-40 to 85	L54B	<a href="#">Samples</a>
LM2940IMPX-8.0/NOPB	ACTIVE	SOT-223	DCY	4	2000	Green (RoHS & no Sb/Br)	CU SN	Level-1-260C-UNLIM	-40 to 85	L54B	<a href="#">Samples</a>
LM2940LD-12	ACTIVE	WSON	NGN	8	1000	TBD	Call TI	Call TI	-40 to 125	L00018B	<a href="#">Samples</a>
LM2940LD-12/NOPB	ACTIVE	WSON	NGN	8	1000	Green (RoHS & no Sb/Br)	CU SN	Level-3-260C-168 HR	-40 to 125	L00018B	<a href="#">Samples</a>
LM2940LD-5.0	ACTIVE	WSON	NGN	8	1000	TBD	Call TI	Call TI	-40 to 125	L00014B	<a href="#">Samples</a>
LM2940LD-5.0/NOPB	ACTIVE	WSON	NGN	8	1000	Green (RoHS & no Sb/Br)	CU SN	Level-3-260C-168 HR	-40 to 125	L00014B	<a href="#">Samples</a>
LM2940S-10	ACTIVE	DDPAK/ TO-263	KTT	3	45	TBD	Call TI	Call TI	-40 to 125	LM2940S -10 P+	<a href="#">Samples</a>
LM2940S-10/NOPB	ACTIVE	DDPAK/ TO-263	KTT	3	45	Pb-Free (RoHS Exempt)	CU SN	Level-3-245C-168 HR	-40 to 125	LM2940S -10 P+	<a href="#">Samples</a>
LM2940S-12	ACTIVE	DDPAK/ TO-263	KTT	3	45	TBD	Call TI	Call TI	-40 to 125	LM2940S -12 P+	<a href="#">Samples</a>
LM2940S-12/NOPB	ACTIVE	DDPAK/ TO-263	KTT	3	45	Pb-Free (RoHS Exempt)	CU SN	Level-3-245C-168 HR	-40 to 125	LM2940S -12 P+	<a href="#">Samples</a>
LM2940S-5.0	ACTIVE	DDPAK/ TO-263	KTT	3	45	TBD	Call TI	Call TI	-40 to 125	LM2940S -5.0 P+	<a href="#">Samples</a>
LM2940S-5.0/NOPB	ACTIVE	DDPAK/ TO-263	KTT	3	45	Pb-Free (RoHS Exempt)	CU SN	Level-3-245C-168 HR	-40 to 125	LM2940S -5.0 P+	<a href="#">Samples</a>
LM2940S-8.0	ACTIVE	DDPAK/ TO-263	KTT	3	45	TBD	Call TI	Call TI	-40 to 125	LM2940S -8.0 P+	<a href="#">Samples</a>
LM2940S-8.0/NOPB	ACTIVE	DDPAK/ TO-263	KTT	3	45	Pb-Free (RoHS Exempt)	CU SN	Level-3-245C-168 HR	-40 to 125	LM2940S -8.0 P+	<a href="#">Samples</a>

Orderable Device	Status (1)	Package Type	Package Drawing	Pins	Package Qty	Eco Plan (2)	Lead/Ball Finish	MSL Peak Temp (3)	Op Temp (°C)	Top-Side Markings (4)	Samples
LM2940S-9.0	ACTIVE	DDPAK/ TO-263	KTT	3	45	TBD	Call TI	Call TI	-40 to 125	LM2940S -9.0 P+	<a href="#">Samples</a>
LM2940S-9.0/NOPB	ACTIVE	DDPAK/ TO-263	KTT	3	45	Pb-Free (RoHS Exempt)	CU SN	Level-3-245C-168 HR	-40 to 125	LM2940S -9.0 P+	<a href="#">Samples</a>
LM2940SX-10	ACTIVE	DDPAK/ TO-263	KTT	3	500	TBD	Call TI	Call TI	-40 to 125	LM2940S -10 P+	<a href="#">Samples</a>
LM2940SX-10/NOPB	ACTIVE	DDPAK/ TO-263	KTT	3	500	Pb-Free (RoHS Exempt)	CU SN	Level-3-245C-168 HR	-40 to 125	LM2940S -10 P+	<a href="#">Samples</a>
LM2940SX-12	ACTIVE	DDPAK/ TO-263	KTT	3	500	TBD	Call TI	Call TI	-40 to 125	LM2940S -12 P+	<a href="#">Samples</a>
LM2940SX-12/NOPB	ACTIVE	DDPAK/ TO-263	KTT	3	500	Pb-Free (RoHS Exempt)	CU SN	Level-3-245C-168 HR	-40 to 125	LM2940S -12 P+	<a href="#">Samples</a>
LM2940SX-5.0	ACTIVE	DDPAK/ TO-263	KTT	3	500	TBD	Call TI	Call TI	-40 to 125	LM2940S -5.0 P+	<a href="#">Samples</a>
LM2940SX-5.0/NOPB	ACTIVE	DDPAK/ TO-263	KTT	3	500	Pb-Free (RoHS Exempt)	CU SN	Level-3-245C-168 HR	-40 to 125	LM2940S -5.0 P+	<a href="#">Samples</a>
LM2940SX-8.0	ACTIVE	DDPAK/ TO-263	KTT	3	500	TBD	Call TI	Call TI	-40 to 125	LM2940S -8.0 P+	<a href="#">Samples</a>
LM2940SX-8.0/NOPB	ACTIVE	DDPAK/ TO-263	KTT	3	500	Pb-Free (RoHS Exempt)	CU SN	Level-3-245C-168 HR	-40 to 125	LM2940S -8.0 P+	<a href="#">Samples</a>
LM2940SX-9.0	ACTIVE	DDPAK/ TO-263	KTT	3	500	TBD	Call TI	Call TI	-40 to 125	LM2940S -9.0 P+	<a href="#">Samples</a>
LM2940SX-9.0/NOPB	ACTIVE	DDPAK/ TO-263	KTT	3	500	Pb-Free (RoHS Exempt)	CU SN	Level-3-245C-168 HR	-40 to 125	LM2940S -9.0 P+	<a href="#">Samples</a>
LM2940T-10.0	ACTIVE	TO-220	NDE	3	45	TBD	Call TI	Call TI	-40 to 125	LM2940T 10.0 P+	<a href="#">Samples</a>
LM2940T-10.0/NOPB	ACTIVE	TO-220	NDE	3	45	Green (RoHS & no Sb/Br)	CU SN	Level-1-NA-UNLIM	-40 to 125	LM2940T 10.0 P+	<a href="#">Samples</a>
LM2940T-12.0	ACTIVE	TO-220	NDE	3	45	TBD	Call TI	Call TI	-40 to 125	LM2940T 12.0 P+	<a href="#">Samples</a>
LM2940T-12.0/NOPB	ACTIVE	TO-220	NDE	3	45	Green (RoHS & no Sb/Br)	CU SN	Level-1-NA-UNLIM	-40 to 125	LM2940T 12.0 P+	<a href="#">Samples</a>
LM2940T-5.0	ACTIVE	TO-220	NDE	3	45	TBD	Call TI	Call TI	-40 to 125	LM2940T -5.0 P+	<a href="#">Samples</a>
LM2940T-5.0/LF08	ACTIVE	TO-220	NEB	3	45	Green (RoHS & no Sb/Br)	CU SN	Level-3-245C-168 HR		LM2940T -5.0 P+	<a href="#">Samples</a>

Orderable Device	Status (1)	Package Type	Package Drawing	Pins	Package Qty	Eco Plan (2)	Lead/Ball Finish	MSL Peak Temp (3)	Op Temp (°C)	Top-Side Markings (4)	Samples
LM2940T-5.0/NOPB	ACTIVE	TO-220	NDE	3	45	Green (RoHS & no Sb/Br)	CU SN	Level-1-NA-UNLIM	-40 to 125	LM2940T -5.0 P+	<a href="#">Samples</a>
LM2940T-8.0	ACTIVE	TO-220	NDE	3	45	TBD	Call TI	Call TI	-40 to 125	LM2940T -8.0 P+	<a href="#">Samples</a>
LM2940T-8.0/NOPB	ACTIVE	TO-220	NDE	3	45	Green (RoHS & no Sb/Br)	CU SN	Level-1-NA-UNLIM	-40 to 125	LM2940T -8.0 P+	<a href="#">Samples</a>
LM2940T-9.0	ACTIVE	TO-220	NDE	3	45	TBD	Call TI	Call TI	-40 to 125	LM2940T -9.0 P+	<a href="#">Samples</a>
LM2940T-9.0/NOPB	ACTIVE	TO-220	NDE	3	45	Green (RoHS & no Sb/Br)	CU SN	Level-1-NA-UNLIM	-40 to 125	LM2940T -9.0 P+	<a href="#">Samples</a>

(1) The marketing status values are defined as follows:

**ACTIVE:** Product device recommended for new designs.

**LIFEBUY:** TI has announced that the device will be discontinued, and a lifetime-buy period is in effect.

**NRND:** Not recommended for new designs. Device is in production to support existing customers, but TI does not recommend using this part in a new design.

**PREVIEW:** Device has been announced but is not in production. Samples may or may not be available.

**OBSELETE:** TI has discontinued the production of the device.

(2) Eco Plan - The planned eco-friendly classification: Pb-Free (RoHS), Pb-Free (RoHS Exempt), or Green (RoHS & no Sb/Br) - please check <http://www.ti.com/productcontent> for the latest availability information and additional product content details.

**TBD:** The Pb-Free/Green conversion plan has not been defined.

**Pb-Free (RoHS):** TI's terms "Lead-Free" or "Pb-Free" mean semiconductor products that are compatible with the current RoHS requirements for all 6 substances, including the requirement that lead not exceed 0.1% by weight in homogeneous materials. Where designed to be soldered at high temperatures, TI Pb-Free products are suitable for use in specified lead-free processes.

**Pb-Free (RoHS Exempt):** This component has a RoHS exemption for either 1) lead-based flip-chip solder bumps used between the die and package, or 2) lead-based die adhesive used between the die and leadframe. The component is otherwise considered Pb-Free (RoHS compatible) as defined above.

**Green (RoHS & no Sb/Br):** TI defines "Green" to mean Pb-Free (RoHS compatible), and free of Bromine (Br) and Antimony (Sb) based flame retardants (Br or Sb do not exceed 0.1% by weight in homogeneous material)

(3) MSL, Peak Temp. -- The Moisture Sensitivity Level rating according to the JEDEC industry standard classifications, and peak solder temperature.

(4) Multiple Top-Side Markings will be inside parentheses. Only one Top-Side Marking contained in parentheses and separated by a "~" will appear on a device. If a line is indented then it is a continuation of the previous line and the two combined represent the entire Top-Side Marking for that device.

**Important Information and Disclaimer:** The information provided on this page represents TI's knowledge and belief as of the date that it is provided. TI bases its knowledge and belief on information provided by third parties, and makes no representation or warranty as to the accuracy of such information. Efforts are underway to better integrate information from third parties. TI has taken and continues to take reasonable steps to provide representative and accurate information but may not have conducted destructive testing or chemical analysis on incoming materials and chemicals. TI and TI suppliers consider certain information to be proprietary, and thus CAS numbers and other limited information may not be available for release.

In no event shall TI's liability arising out of such information exceed the total purchase price of the TI part(s) at issue in this document sold by TI to Customer on an annual basis.



**TAPE AND REEL INFORMATION**

**QUADRANT ASSIGNMENTS FOR PIN 1 ORIENTATION IN TAPE**

\*All dimensions are nominal

Device	Package Type	Package Drawing	Pins	SPQ	Reel Diameter (mm)	Reel Width W1 (mm)	A0 (mm)	B0 (mm)	K0 (mm)	P1 (mm)	W (mm)	Pin1 Quadrant
LM2940CSX-12	DDPAK/ TO-263	KTT	3	500	330.0	24.4	10.75	14.85	5.0	16.0	24.0	Q2
LM2940CSX-12/NOPB	DDPAK/ TO-263	KTT	3	500	330.0	24.4	10.75	14.85	5.0	16.0	24.0	Q2
LM2940CSX-15	DDPAK/ TO-263	KTT	3	500	330.0	24.4	10.75	14.85	5.0	16.0	24.0	Q2
LM2940CSX-15/NOPB	DDPAK/ TO-263	KTT	3	500	330.0	24.4	10.75	14.85	5.0	16.0	24.0	Q2
LM2940CSX-5.0	DDPAK/ TO-263	KTT	3	500	330.0	24.4	10.75	14.85	5.0	16.0	24.0	Q2
LM2940CSX-5.0/NOPB	DDPAK/ TO-263	KTT	3	500	330.0	24.4	10.75	14.85	5.0	16.0	24.0	Q2
LM2940CSX-9.0	DDPAK/ TO-263	KTT	3	500	330.0	24.4	10.75	14.85	5.0	16.0	24.0	Q2
LM2940CSX-9.0/NOPB	DDPAK/ TO-263	KTT	3	500	330.0	24.4	10.75	14.85	5.0	16.0	24.0	Q2
LM2940IMP-10	SOT-223	DCY	4	1000	330.0	16.4	7.0	7.5	2.2	12.0	16.0	Q3
LM2940IMP-10/NOPB	SOT-223	DCY	4	1000	330.0	16.4	7.0	7.5	2.2	12.0	16.0	Q3
LM2940IMP-12	SOT-223	DCY	4	1000	330.0	16.4	7.0	7.5	2.2	12.0	16.0	Q3
LM2940IMP-12/NOPB	SOT-223	DCY	4	1000	330.0	16.4	7.0	7.5	2.2	12.0	16.0	Q3

Device	Package Type	Package Drawing	Pins	SPQ	Reel Diameter (mm)	Reel Width W1 (mm)	A0 (mm)	B0 (mm)	K0 (mm)	P1 (mm)	W (mm)	Pin1 Quadrant
LM2940IMP-15	SOT-223	DCY	4	1000	330.0	16.4	7.0	7.5	2.2	12.0	16.0	Q3
LM2940IMP-15/NOPB	SOT-223	DCY	4	1000	330.0	16.4	7.0	7.5	2.2	12.0	16.0	Q3
LM2940IMP-5.0	SOT-223	DCY	4	1000	330.0	16.4	7.0	7.5	2.2	12.0	16.0	Q3
LM2940IMP-5.0/NOPB	SOT-223	DCY	4	1000	330.0	16.4	7.0	7.5	2.2	12.0	16.0	Q3
LM2940IMP-9.0	SOT-223	DCY	4	1000	330.0	16.4	7.0	7.5	2.2	12.0	16.0	Q3
LM2940IMP-9.0/NOPB	SOT-223	DCY	4	1000	330.0	16.4	7.0	7.5	2.2	12.0	16.0	Q3
LM2940IMPX-10	SOT-223	DCY	4	2000	330.0	16.4	7.0	7.5	2.2	12.0	16.0	Q3
LM2940IMPX-10/NOPB	SOT-223	DCY	4	2000	330.0	16.4	7.0	7.5	2.2	12.0	16.0	Q3
LM2940IMPX-12	SOT-223	DCY	4	2000	330.0	16.4	7.0	7.5	2.2	12.0	16.0	Q3
LM2940IMPX-12/NOPB	SOT-223	DCY	4	2000	330.0	16.4	7.0	7.5	2.2	12.0	16.0	Q3
LM2940IMPX-5.0	SOT-223	DCY	4	2000	330.0	16.4	7.0	7.5	2.2	12.0	16.0	Q3
LM2940IMPX-5.0/NOPB	SOT-223	DCY	4	2000	330.0	16.4	7.0	7.5	2.2	12.0	16.0	Q3
LM2940IMPX-8.0	SOT-223	DCY	4	2000	330.0	16.4	7.0	7.5	2.2	12.0	16.0	Q3
LM2940IMPX-8.0/NOPB	SOT-223	DCY	4	2000	330.0	16.4	7.0	7.5	2.2	12.0	16.0	Q3
LM2940LD-12	WSON	NGN	8	1000	178.0	12.4	4.3	4.3	1.3	8.0	12.0	Q1
LM2940LD-12/NOPB	WSON	NGN	8	1000	178.0	12.4	4.3	4.3	1.3	8.0	12.0	Q1
LM2940LD-5.0	WSON	NGN	8	1000	178.0	12.4	4.3	4.3	1.3	8.0	12.0	Q1
LM2940LD-5.0/NOPB	WSON	NGN	8	1000	178.0	12.4	4.3	4.3	1.3	8.0	12.0	Q1
LM2940SX-10	DDPAK/ TO-263	KTT	3	500	330.0	24.4	10.75	14.85	5.0	16.0	24.0	Q2
LM2940SX-10/NOPB	DDPAK/ TO-263	KTT	3	500	330.0	24.4	10.75	14.85	5.0	16.0	24.0	Q2
LM2940SX-12	DDPAK/ TO-263	KTT	3	500	330.0	24.4	10.75	14.85	5.0	16.0	24.0	Q2
LM2940SX-12/NOPB	DDPAK/ TO-263	KTT	3	500	330.0	24.4	10.75	14.85	5.0	16.0	24.0	Q2
LM2940SX-5.0	DDPAK/ TO-263	KTT	3	500	330.0	24.4	10.75	14.85	5.0	16.0	24.0	Q2
LM2940SX-5.0/NOPB	DDPAK/ TO-263	KTT	3	500	330.0	24.4	10.75	14.85	5.0	16.0	24.0	Q2
LM2940SX-8.0	DDPAK/ TO-263	KTT	3	500	330.0	24.4	10.75	14.85	5.0	16.0	24.0	Q2
LM2940SX-8.0/NOPB	DDPAK/ TO-263	KTT	3	500	330.0	24.4	10.75	14.85	5.0	16.0	24.0	Q2
LM2940SX-9.0	DDPAK/ TO-263	KTT	3	500	330.0	24.4	10.75	14.85	5.0	16.0	24.0	Q2
LM2940SX-9.0/NOPB	DDPAK/ TO-263	KTT	3	500	330.0	24.4	10.75	14.85	5.0	16.0	24.0	Q2

**TAPE AND REEL BOX DIMENSIONS**

\*All dimensions are nominal

Device	Package Type	Package Drawing	Pins	SPQ	Length (mm)	Width (mm)	Height (mm)
LM2940CSX-12	DDPAK/TO-263	KTT	3	500	367.0	367.0	45.0
LM2940CSX-12/NOPB	DDPAK/TO-263	KTT	3	500	367.0	367.0	45.0
LM2940CSX-15	DDPAK/TO-263	KTT	3	500	367.0	367.0	45.0
LM2940CSX-15/NOPB	DDPAK/TO-263	KTT	3	500	367.0	367.0	45.0
LM2940CSX-5.0	DDPAK/TO-263	KTT	3	500	367.0	367.0	45.0
LM2940CSX-5.0/NOPB	DDPAK/TO-263	KTT	3	500	367.0	367.0	45.0
LM2940CSX-9.0	DDPAK/TO-263	KTT	3	500	367.0	367.0	45.0
LM2940CSX-9.0/NOPB	DDPAK/TO-263	KTT	3	500	367.0	367.0	45.0
LM2940IMP-10	SOT-223	DCY	4	1000	367.0	367.0	35.0
LM2940IMP-10/NOPB	SOT-223	DCY	4	1000	367.0	367.0	35.0
LM2940IMP-12	SOT-223	DCY	4	1000	367.0	367.0	35.0
LM2940IMP-12/NOPB	SOT-223	DCY	4	1000	367.0	367.0	35.0
LM2940IMP-15	SOT-223	DCY	4	1000	367.0	367.0	35.0
LM2940IMP-15/NOPB	SOT-223	DCY	4	1000	367.0	367.0	35.0
LM2940IMP-5.0	SOT-223	DCY	4	1000	367.0	367.0	35.0
LM2940IMP-5.0/NOPB	SOT-223	DCY	4	1000	367.0	367.0	35.0
LM2940IMP-9.0	SOT-223	DCY	4	1000	367.0	367.0	35.0
LM2940IMP-9.0/NOPB	SOT-223	DCY	4	1000	367.0	367.0	35.0
LM2940IMPX-10	SOT-223	DCY	4	2000	367.0	367.0	35.0
LM2940IMPX-10/NOPB	SOT-223	DCY	4	2000	367.0	367.0	35.0

Device	Package Type	Package Drawing	Pins	SPQ	Length (mm)	Width (mm)	Height (mm)
LM2940IMPX-12	SOT-223	DCY	4	2000	367.0	367.0	35.0
LM2940IMPX-12/NOPB	SOT-223	DCY	4	2000	367.0	367.0	35.0
LM2940IMPX-5.0	SOT-223	DCY	4	2000	367.0	367.0	35.0
LM2940IMPX-5.0/NOPB	SOT-223	DCY	4	2000	367.0	367.0	35.0
LM2940IMPX-8.0	SOT-223	DCY	4	2000	367.0	367.0	35.0
LM2940IMPX-8.0/NOPB	SOT-223	DCY	4	2000	367.0	367.0	35.0
LM2940LD-12	WSON	NGN	8	1000	210.0	185.0	35.0
LM2940LD-12/NOPB	WSON	NGN	8	1000	213.0	191.0	55.0
LM2940LD-5.0	WSON	NGN	8	1000	210.0	185.0	35.0
LM2940LD-5.0/NOPB	WSON	NGN	8	1000	213.0	191.0	55.0
LM2940SX-10	DDPAK/TO-263	KTT	3	500	367.0	367.0	45.0
LM2940SX-10/NOPB	DDPAK/TO-263	KTT	3	500	367.0	367.0	45.0
LM2940SX-12	DDPAK/TO-263	KTT	3	500	367.0	367.0	45.0
LM2940SX-12/NOPB	DDPAK/TO-263	KTT	3	500	367.0	367.0	45.0
LM2940SX-5.0	DDPAK/TO-263	KTT	3	500	367.0	367.0	45.0
LM2940SX-5.0/NOPB	DDPAK/TO-263	KTT	3	500	367.0	367.0	45.0
LM2940SX-8.0	DDPAK/TO-263	KTT	3	500	367.0	367.0	45.0
LM2940SX-8.0/NOPB	DDPAK/TO-263	KTT	3	500	367.0	367.0	45.0
LM2940SX-9.0	DDPAK/TO-263	KTT	3	500	367.0	367.0	45.0
LM2940SX-9.0/NOPB	DDPAK/TO-263	KTT	3	500	367.0	367.0	45.0

NDE0003B



NDG0003F

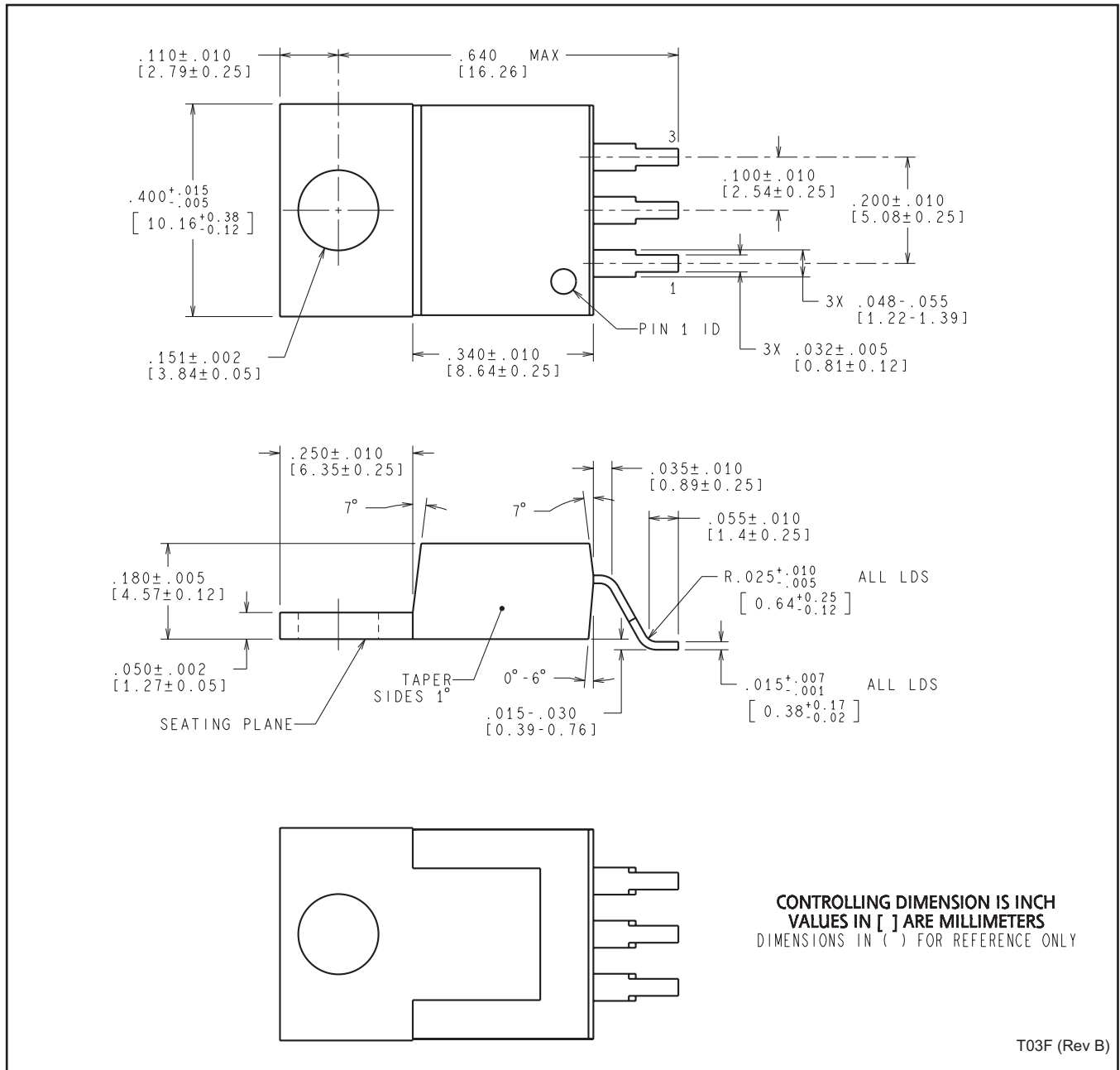

T03F (Rev B)

DCY (R-PDSO-G4)

PLASTIC SMALL-OUTLINE



- NOTES: A. All linear dimensions are in millimeters (inches).  
 B. This drawing is subject to change without notice.  
 C. Body dimensions do not include mold flash or protrusion.  
 D. Falls within JEDEC TO-261 Variation AA.





KTT0003B



TS3B (Rev F)

NEB0003G

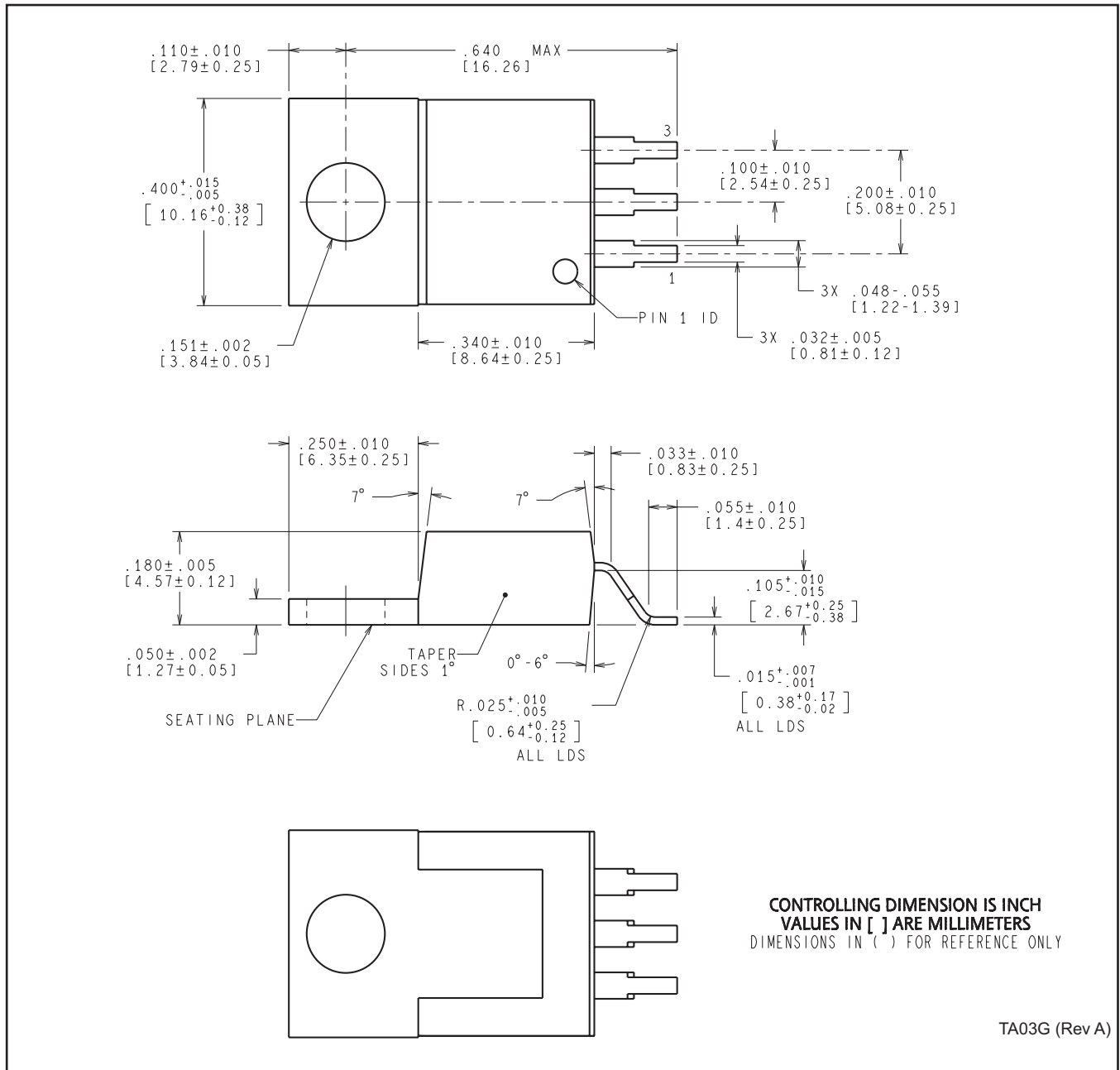

## IMPORTANT NOTICE

Texas Instruments Incorporated and its subsidiaries (TI) reserve the right to make corrections, enhancements, improvements and other changes to its semiconductor products and services per JESD46, latest issue, and to discontinue any product or service per JESD48, latest issue. Buyers should obtain the latest relevant information before placing orders and should verify that such information is current and complete. All semiconductor products (also referred to herein as "components") are sold subject to TI's terms and conditions of sale supplied at the time of order acknowledgment.

TI warrants performance of its components to the specifications applicable at the time of sale, in accordance with the warranty in TI's terms and conditions of sale of semiconductor products. Testing and other quality control techniques are used to the extent TI deems necessary to support this warranty. Except where mandated by applicable law, testing of all parameters of each component is not necessarily performed.

TI assumes no liability for applications assistance or the design of Buyers' products. Buyers are responsible for their products and applications using TI components. To minimize the risks associated with Buyers' products and applications, Buyers should provide adequate design and operating safeguards.

TI does not warrant or represent that any license, either express or implied, is granted under any patent right, copyright, mask work right, or other intellectual property right relating to any combination, machine, or process in which TI components or services are used. Information published by TI regarding third-party products or services does not constitute a license to use such products or services or a warranty or endorsement thereof. Use of such information may require a license from a third party under the patents or other intellectual property of the third party, or a license from TI under the patents or other intellectual property of TI.

Reproduction of significant portions of TI information in TI data books or data sheets is permissible only if reproduction is without alteration and is accompanied by all associated warranties, conditions, limitations, and notices. TI is not responsible or liable for such altered documentation. Information of third parties may be subject to additional restrictions.

Resale of TI components or services with statements different from or beyond the parameters stated by TI for that component or service voids all express and any implied warranties for the associated TI component or service and is an unfair and deceptive business practice. TI is not responsible or liable for any such statements.

Buyer acknowledges and agrees that it is solely responsible for compliance with all legal, regulatory and safety-related requirements concerning its products, and any use of TI components in its applications, notwithstanding any applications-related information or support that may be provided by TI. Buyer represents and agrees that it has all the necessary expertise to create and implement safeguards which anticipate dangerous consequences of failures, monitor failures and their consequences, lessen the likelihood of failures that might cause harm and take appropriate remedial actions. Buyer will fully indemnify TI and its representatives against any damages arising out of the use of any TI components in safety-critical applications.

In some cases, TI components may be promoted specifically to facilitate safety-related applications. With such components, TI's goal is to help enable customers to design and create their own end-product solutions that meet applicable functional safety standards and requirements. Nonetheless, such components are subject to these terms.

No TI components are authorized for use in FDA Class III (or similar life-critical medical equipment) unless authorized officers of the parties have executed a special agreement specifically governing such use.

Only those TI components which TI has specifically designated as military grade or "enhanced plastic" are designed and intended for use in military/aerospace applications or environments. Buyer acknowledges and agrees that any military or aerospace use of TI components which have **not** been so designated is solely at the Buyer's risk, and that Buyer is solely responsible for compliance with all legal and regulatory requirements in connection with such use.

TI has specifically designated certain components as meeting ISO/TS16949 requirements, mainly for automotive use. In any case of use of non-designated products, TI will not be responsible for any failure to meet ISO/TS16949.

### Products

Audio	<a href="http://www.ti.com/audio">www.ti.com/audio</a>
Amplifiers	<a href="http://amplifier.ti.com">amplifier.ti.com</a>
Data Converters	<a href="http://dataconverter.ti.com">dataconverter.ti.com</a>
DLP® Products	<a href="http://www.dlp.com">www.dlp.com</a>
DSP	<a href="http://dsp.ti.com">dsp.ti.com</a>
Clocks and Timers	<a href="http://www.ti.com/clocks">www.ti.com/clocks</a>
Interface	<a href="http://interface.ti.com">interface.ti.com</a>
Logic	<a href="http://logic.ti.com">logic.ti.com</a>
Power Mgmt	<a href="http://power.ti.com">power.ti.com</a>
Microcontrollers	<a href="http://microcontroller.ti.com">microcontroller.ti.com</a>
RFID	<a href="http://www.ti-rfid.com">www.ti-rfid.com</a>
OMAP Applications Processors	<a href="http://www.ti.com/omap">www.ti.com/omap</a>
Wireless Connectivity	<a href="http://www.ti.com/wirelessconnectivity">www.ti.com/wirelessconnectivity</a>

### Applications

Automotive and Transportation	<a href="http://www.ti.com/automotive">www.ti.com/automotive</a>
Communications and Telecom	<a href="http://www.ti.com/communications">www.ti.com/communications</a>
Computers and Peripherals	<a href="http://www.ti.com/computers">www.ti.com/computers</a>
Consumer Electronics	<a href="http://www.ti.com/consumer-apps">www.ti.com/consumer-apps</a>
Energy and Lighting	<a href="http://www.ti.com/energy">www.ti.com/energy</a>
Industrial	<a href="http://www.ti.com/industrial">www.ti.com/industrial</a>
Medical	<a href="http://www.ti.com/medical">www.ti.com/medical</a>
Security	<a href="http://www.ti.com/security">www.ti.com/security</a>
Space, Avionics and Defense	<a href="http://www.ti.com/space-avionics-defense">www.ti.com/space-avionics-defense</a>
Video and Imaging	<a href="http://www.ti.com/video">www.ti.com/video</a>

### TI E2E Community

[e2e.ti.com](http://e2e.ti.com)