

1200V, 25A, Trench FS II Fast IGBT

General Description

Using NCE's proprietary trench design and advanced FS (Field Stop) second generation technology, the 1200V Trench FSII IGBT offers superior conduction and switching performances, and easy parallel operation;

Features

- Trench FSII Technology offering
- Very low $V_{CE(sat)}$
- High speed switching
- Positive temperature coefficient in $V_{CE(sat)}$
- Very tight parameter distribution
- High ruggedness, temperature stable behavior

Application

- Welding

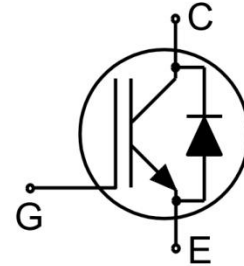

Schematic diagram

Package Marking and Ordering Information

Device	Device Package	Device Marking
NCE25TD120WT	TO-247	NCE25TD120WT



TO-247

Absolute Maximum Ratings ($T_C=25^\circ\text{C}$ unless otherwise noted)

Symbol	Parameter	Value	Units
V_{CES}	Collector-Emitter Voltage	1200	V
V_{GES}	Gate- Emitter Voltage	± 30	V
I_C	Collector Current	50	A
	Collector Current @ $T_C = 100^\circ\text{C}$	25	A
I_{Cpuls}	Pulsed Collector Current, t_p limited by T_{jmax}	100	A
-	turn off safe operating area, $V_{CE}=1200\text{V}$, $T_J=175^\circ\text{C}$	100	A
I_F	Diode Continuous Forward Current @ $T_C = 100^\circ\text{C}$	25	A
I_{FM}	Diode Maximum Forward Current	100	A
P_D	Power Dissipation @ $T_C = 25^\circ\text{C}$	365	W
	Power Dissipation @ $T_C = 100^\circ\text{C}$	183	W
T_J, T_{stg}	Operating Junction and Storage Temperature Range	-55 to +175	$^\circ\text{C}$
T_L	Maximum Temperature for Soldering	260	$^\circ\text{C}$

Thermal Characteristic

Symbol	Parameter	Value	Units
$R_{\theta JC}$	Thermal Resistance, Junction to case for IGBT	0.41	$^{\circ}\text{C/W}$
$R_{\theta JC}$	Thermal Resistance, Junction to case for Diode	0.93	$^{\circ}\text{C/W}$
$R_{\theta JA}$	Thermal Resistance, Junction to Ambient	40	$^{\circ}\text{C/W}$

Electrical Characteristics ($T_c=25^{\circ}\text{C}$ unless otherwise noted)

Symbol	Parameter	Conditions	Value			Units	
			Min.	Typ.	Max.		
Static Characteristics							
$V_{(BR)CES}$	Collector-Emitter Breakdown Voltage	$V_{GE}=0V, I_{CE}=1mA$	1200	--	--	V	
I_{CES}	Collector-Emitter Leakage Current	$V_{GE}=0V, V_{CE}=1200V$	--	--	100	μA	
$I_{GES(F)}$	Gate to Emitter Forward Leakage	$V_{GE}=+30V, V_{CE}=0V$	--	--	200	nA	
$I_{GES(R)}$	Gate to Emitter Reverse Leakage	$V_{GE}=-30V, V_{CE}=0V$	--	--	200	nA	
$V_{CE(sat)}$	Collector-Emitter Saturation Voltage	$V_{GE}=15V,$ $I_C=25A,$	$T_J=25^{\circ}\text{C}$	--	1.9	2.4	V
			$T_J=175^{\circ}\text{C}$	--	2.2	--	
$V_{GE(th)}$	Gate Threshold Voltage	$I_C=1mA, V_{CE}=V_{GE}$	4.5	--	6.5	V	
Dynamic Characteristics							
C_{ies}	Input Capacitance	$V_{CE}=30V, V_{GE}=0V,$ $f=1\text{MHz}$	--	3094	--	pF	
C_{oes}	Output Capacitance		--	86	--		
C_{res}	Reverse Transfer Capacitance		--	68	--		
Q_g	Total Gate Charge	$V_{CC}=960V, I_C=25A$ $V_{GE}=15V$	--	123	--	nC	
Q_{ge}	Gate to Emitter Charge		--	28	--	nC	
Q_{gc}	Gate to Collector Charge		--	60	--	nC	
Switching Characteristics							
$t_{d(ON)}$	Turn-on Delay Time	$V_{CE}=600V, I_C=25A$ $V_{GE}=0/15V, R_g=8\Omega$ Inductive Load	--	19	--	ns	
t_r	Rise Time		--	17	--		
$t_{d(OFF)}$	Turn-Off Delay Time		--	170	--		
t_f	Fall Time		--	18	--		
E_{on}	Turn-On Switching Loss		--	1.2	--	mJ	
E_{off}	Turn-Off Switching Loss		--	0.6	--		
E_{ts}	Total Switching Loss	--	1.8	--			

Electrical Characteristics of the Diode ($T_c=25^{\circ}\text{C}$ unless otherwise specified)

Symbol	Parameter	Conditions	Rating			Units
			Min.	Typ.	Max.	
V_{FM}	Diode Forward Voltage	$I_F=12.5A$	--	2.1	2.8	V
T_{rr}	Reverse Recovery Time	$I_F=12.5A,$ $di/dt=500A/\mu\text{s}$	--	118	--	ns
I_{RRM}	Diode Peak Reverse Recovery Current		--	12	--	A
Q_{rr}	Reverse Recovery Charge		--	0.72	--	μC
Pulse width $t_p \leq 380\mu\text{s}, \delta \leq 2\%$						

Test Circuit

1) Gate Charge Test Circuit

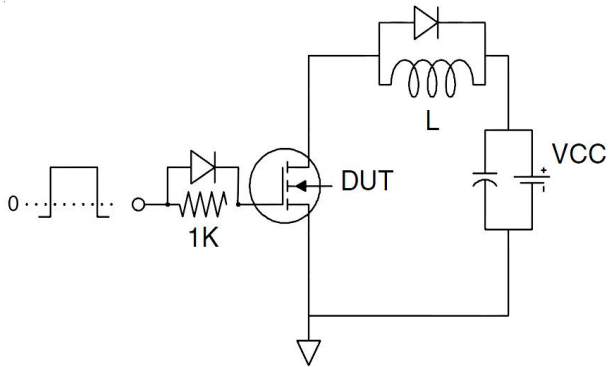

2) Switch Time Test Circuit

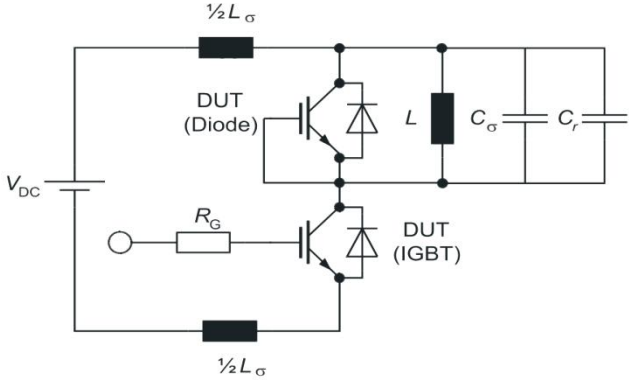

Switching characteristics

1) definition of switching times

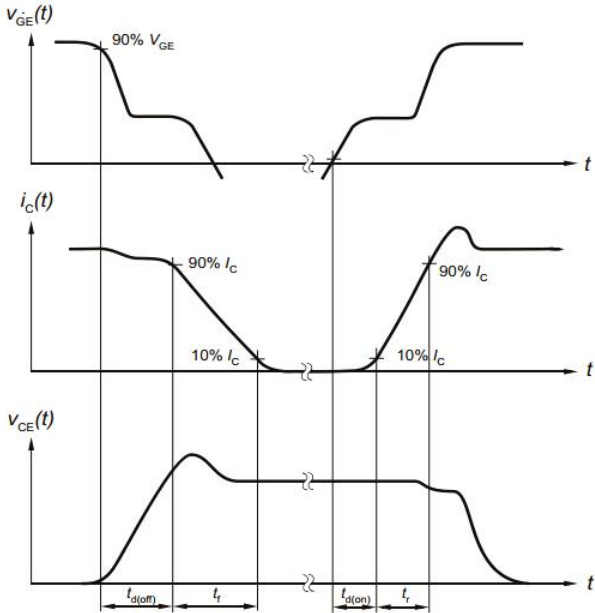

2) definition of switching losses

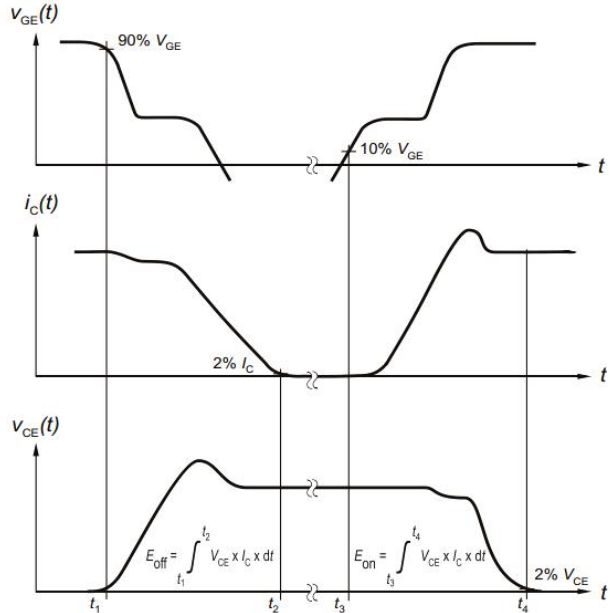

3) Definition of diode switching characteristics

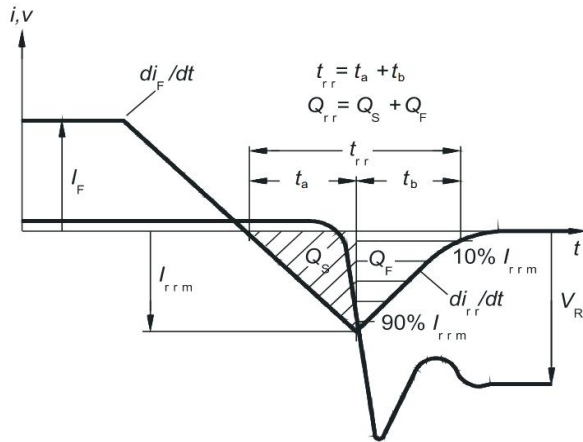

Typical Electrical and Thermal Characteristics

Figure 1 Output Characteristics

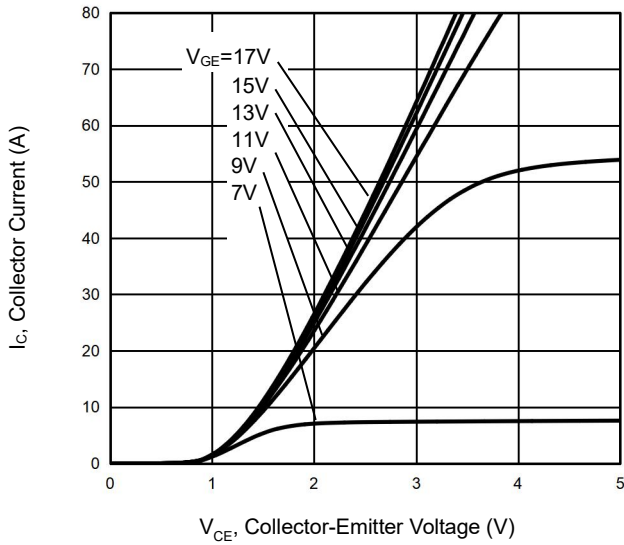

Figure 2 Transfer Characteristics

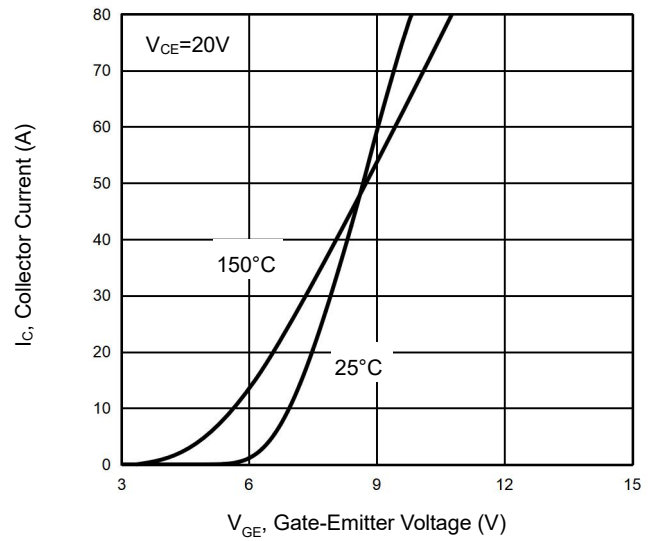

Figure 3 $V_{CE(sat)}$ vs. Case Temperature

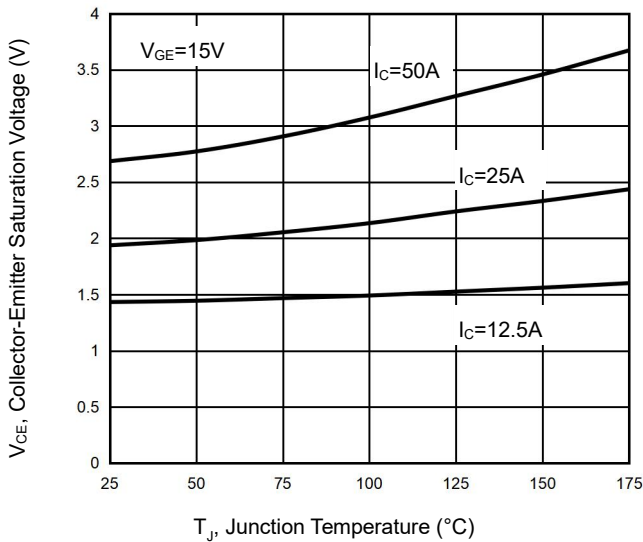

Figure 4 Saturation Voltage vs. V_{GE}

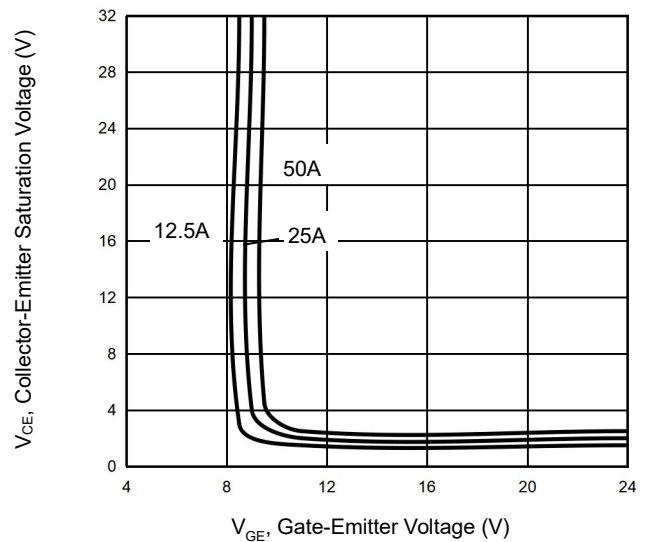

Figure 5 Capacitance Characteristics

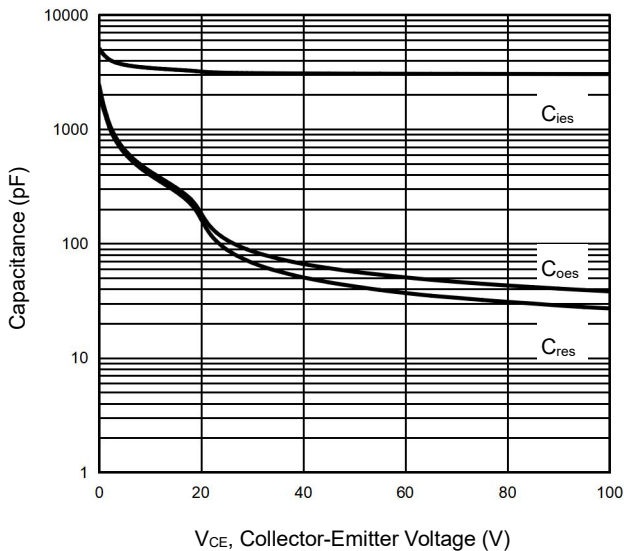
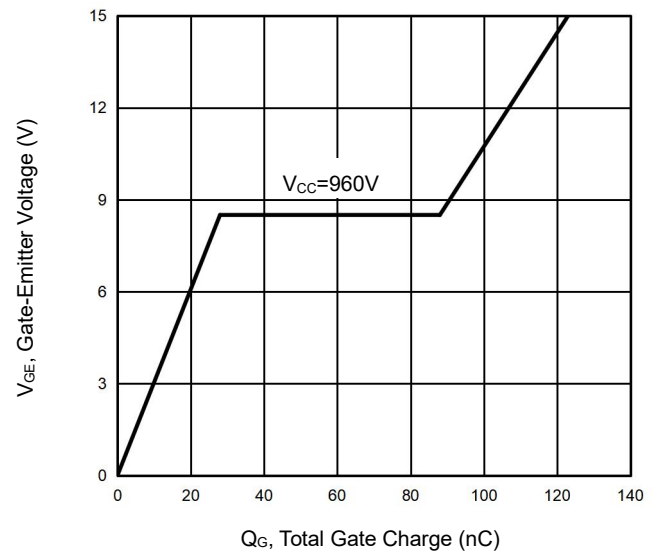

Figure 6 Gate Charge Wave Form



Typical Electrical and Thermal Characteristics

Figure 7 Forward Characteristics

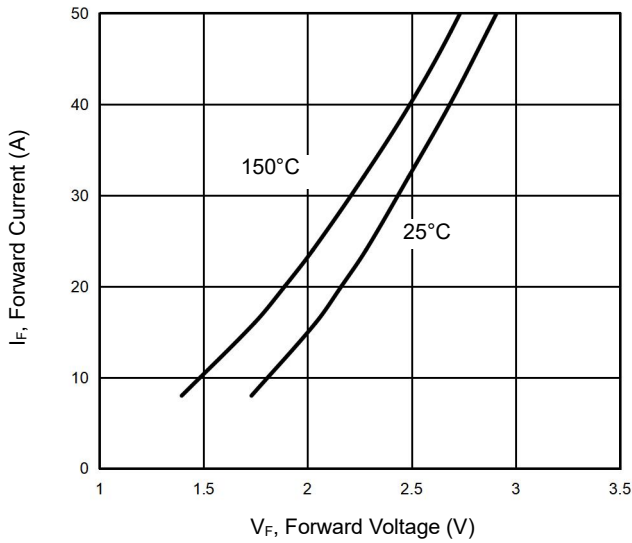

Figure 8 V_F vs. Temperature

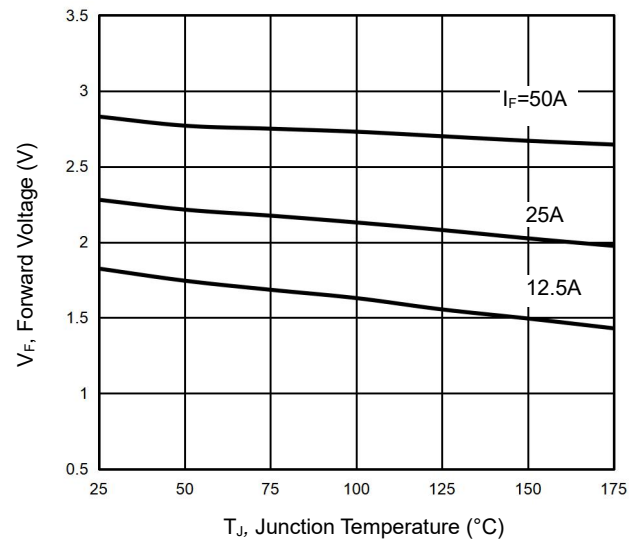

Figure 9 Switching Energy vs. Temperature

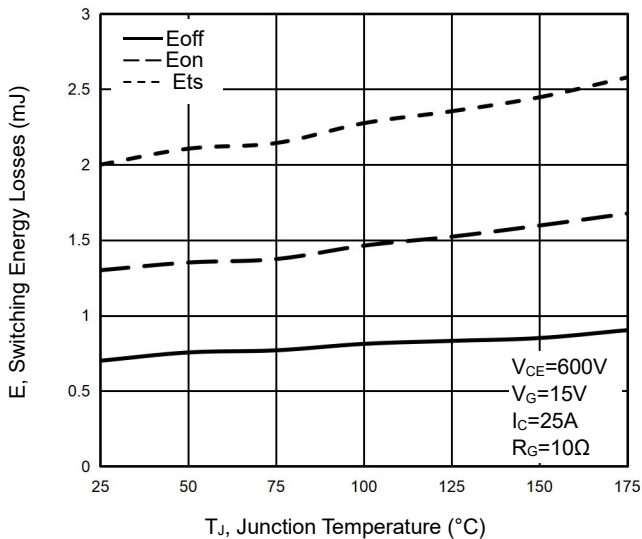

Figure 10 Forward Bias Safe Operating Area

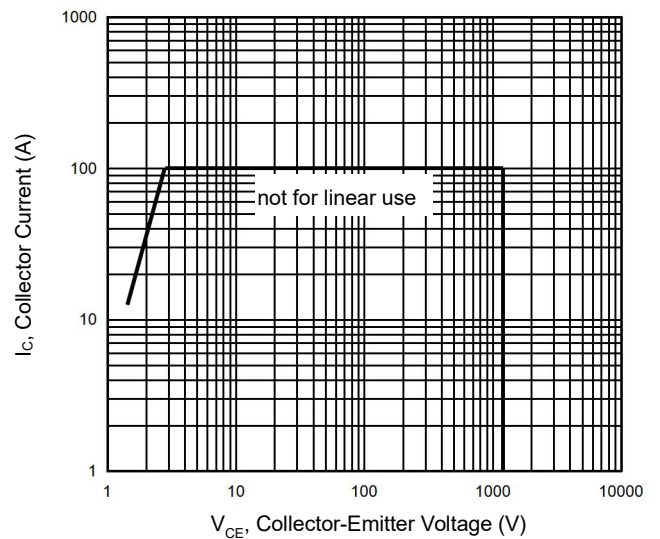

Figure 11 Gate-Emitter Threshold Voltage as a Function of Junction Temperature

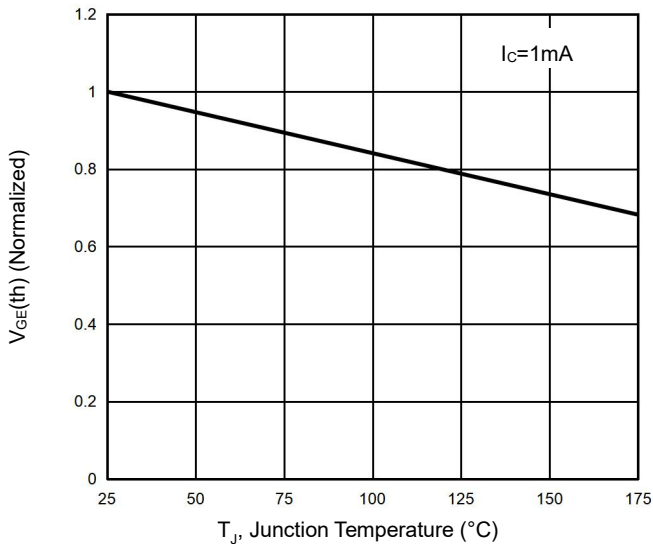
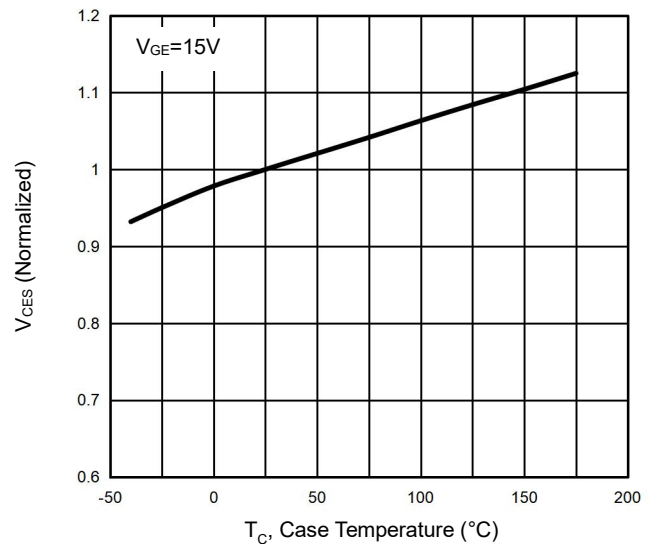

Figure 12 V_{CES} vs. Temperature



Typical Electrical and Thermal Characteristics

Figure 13 Switching Loss vs. R_G

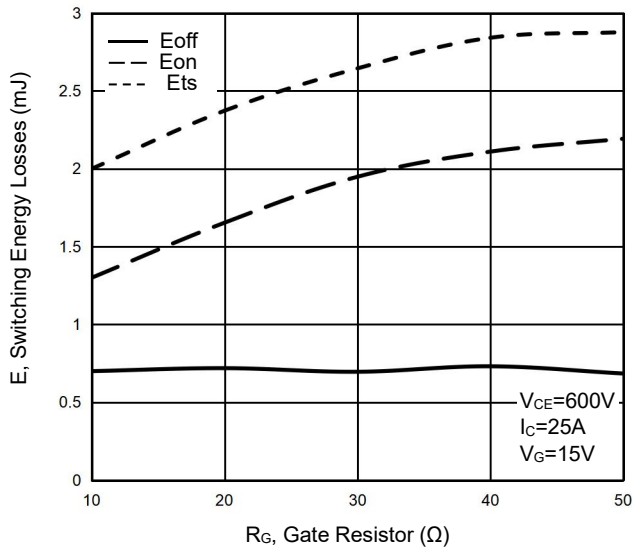

Figure 14 Switching Loss vs. Collector Current

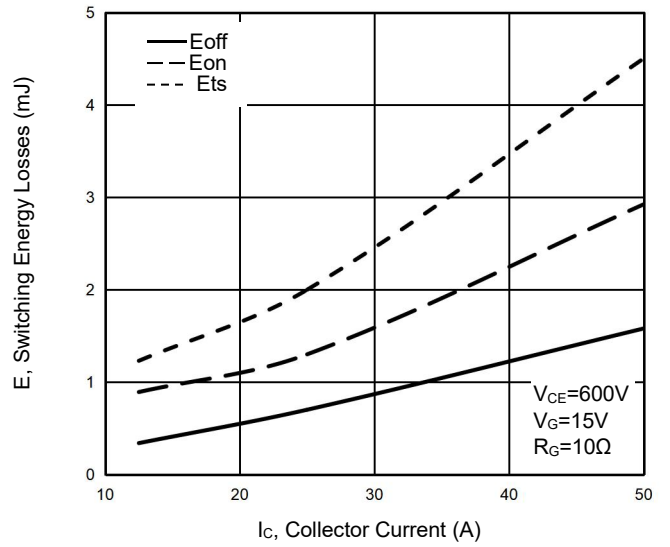

Figure 15 Switching Loss vs. Collector Current

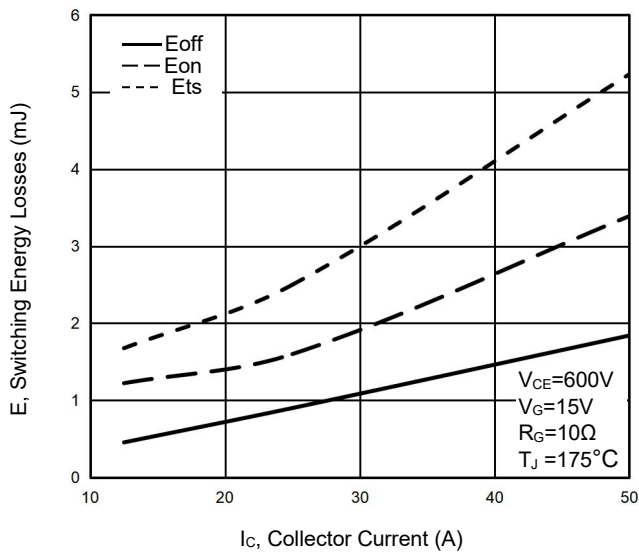

Figure 16 P_{tot} vs. Case Temperature

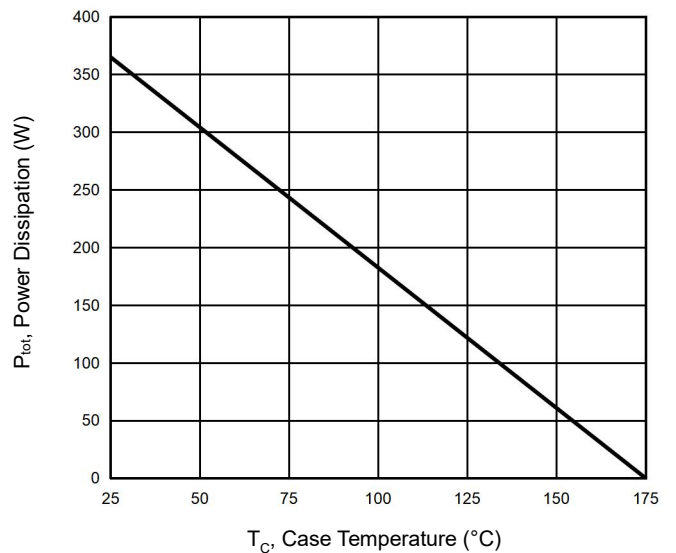

Figure 17 V_{CES} vs. Temperature

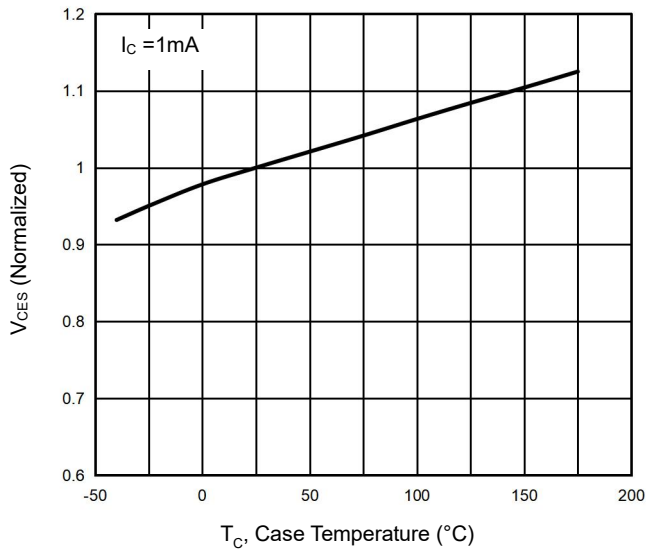
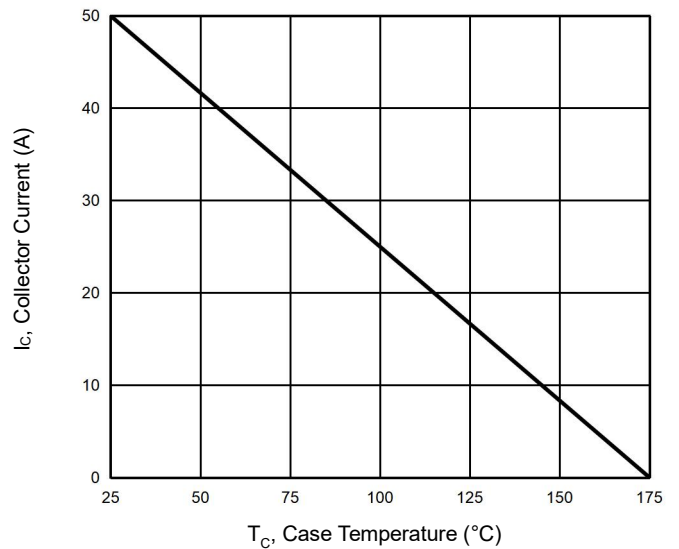
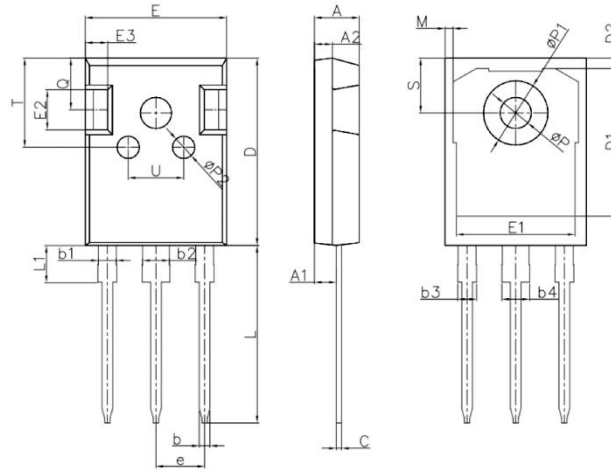

Figure 18 I_C vs. Temperature



TO-247-E Package Information



Symbol	Dimensions In Millimeters		Dimensions In Inches	
	Min.	Max.	Min.	Max.
A	4.90	5.10	0.19	0.20
A1	2.31	2.51	0.09	0.10
A2	1.90	2.10	0.07	0.08
b	1.16	1.26	0.05	0.06
b1	1.96	2.06	0.08	0.09
b2	2.96	3.06	0.12	0.13
b3	--	2.25	--	0.09
b4	--	3.25	--	0.13
c	0.59	0.66	0.02	0.03
D	20.90	21.10	0.82	0.83
D1	16.25	16.85	0.64	0.66
D2	1.05	1.35	0.04	0.05
E	15.70	15.90	0.62	0.63
E1	13.10	13.50	0.52	0.53
E2	4.40	4.60	0.17	0.18
E3	2.40	2.60	0.09	0.10
e	5.436 BSC		0.214 BSC	
L	19.80	20.10	0.78	0.79
L1	--	4.30	--	0.17
M	0.35	0.95	0.01	0.04
P	3.40	3.60	0.13	0.14
P1	7.00	7.40	0.28	0.29
P2	2.40	2.60	0.09	0.10
Q	5.60	6.00	0.22	0.24
S	6.05	6.25	0.24	0.25
T	9.80	10.20	0.39	0.40
U	6.00	6.40	0.24	0.25

Attention:

- Any and all NCE power products described or contained herein do not have specifications that can handle applications that require extremely high levels of reliability, such as life-support systems, aircraft's control systems, or other applications whose failure can be reasonably expected to result in serious physical and/or material damage. Consult with your NCE power representative nearest you before using any NCE power products described or contained herein in such applications.
- NCE power assumes no responsibility for equipment failures that result from using products at values that exceed, even momentarily, rated values (such as maximum ratings, operating condition ranges, or other parameters) listed in products specifications of any and all NCE power products described or contained herein.
- Specifications of any and all NCE power products described or contained herein stipulate the performance, characteristics, and functions of the described products in the independent state, and are not guarantees of the performance, characteristics, and functions of the described products as mounted in the customer's products or equipment. To verify symptoms and states that cannot be evaluated in an independent device, the customer should always evaluate and test devices mounted in the customer's products or equipment.
- NCE power Semiconductor CO.,LTD. strives to supply high-quality high-reliability products. However, any and all semiconductor products fail with some probability. It is possible that these probabilistic failures could give rise to accidents or events that could endanger human lives, that could give rise to smoke or fire, or that could cause damage to other property. When designing equipment, adopt safety measures so that these kinds of accidents or events cannot occur. Such measures include but are not limited to protective circuits and error prevention circuits for safe design, redundant design, and structural design.
- In the event that any or all NCE power products(including technical data, services) described or contained herein are controlled under any of applicable local export control laws and regulations, such products must not be exported without obtaining the export license from the authorities concerned in accordance with the above law.
- No part of this publication may be reproduced or transmitted in any form or by any means, electronic or mechanical, including photocopying and recording, or any information storage or retrieval system, or otherwise, without the prior written permission of NCE power Semiconductor CO.,LTD.
- Information (including circuit diagrams and circuit parameters) herein is for example only ; it is not guaranteed for volume production. NCE power believes information herein is accurate and reliable, but no guarantees are made or implied regarding its use or any infringements of intellectual property rights or other rights of third parties.
- Any and all information described or contained herein are subject to change without notice due to product/technology improvement, etc. When designing equipment, refer to the "Delivery Specification" for the NCE power product that you intend to use.
- This catalog provides information as of Sep.2010. Specifications and information herein are subject to change without notice.